

SE-S10

Electronic Cash Register



(SE-S10 small drawer model)

User's Manual

Click here for online support

www.CasioHelp.co.uk

CASIO COMPUTER CO., LTD.
6-2, Hon-machi 1-chome
Shibuya-ku, Tokyo 151-8543, Japan

CASIO[®]

EU
DI
UK

Thank you very much for purchasing this CASIO electronic cash register.

START-UP is QUICK and EASY!

Part-1 of this User's Manual can help you make a quick start.

Once you have mastered the QUICK START operations, you will undoubtedly want to expand your use of this machine by studying other sections of Part-2.

Original Carton/Package

If for any reason, this product is to be returned to the store where purchased, it must be packed in the original carton/package.

Location

Locate the Cash register on a flat, stable surface, away from heaters or areas exposed to direct sunlight, humidity or dust.

Power Supply

Your cash register is designed to operate on standard household current (120V, 220V, 230V or 240V; 50/60Hz). Do not overload the outlet by plugging in too many appliances.

Cleaning

Clean the cash register exterior with a soft cloth which has been moistened with a solution of a mild neutral detergent and water, and wrung out.

Be sure that the cloth is thoroughly wrung out to avoid damage to the printer.

Never use paint thinner, benzene, or other volatile solvents.

The mains plug on this equipment must be used to disconnect mains power. Please ensure that the socket outlet is installed near the equipment and shall be easily accessible.

Safety precautions

- To use this product safely and correctly, read this manual thoroughly and operate as instructed. After reading this guide, keep it close at hand for easy reference. Please keep all informations for future reference.
- Always observe the warnings and cautions indicated on the product.

About the icons

In this guide various icons are used to highlight safe operation of this product and to prevent injury to the operator and other personnel and also to prevent damage to property and this product. The icons and definitions are given below.



Indicates that there is a risk of severe injury or death if used incorrectly.



Indicates that injury or damage may result if used incorrectly.

Icon examples

To bring attention to risks and possible damage, the following types of icons are used.



The \triangle symbol indicates that it includes some symbol for attracting attention (including warning). In this triangle the actual type of precautions to be taken (electric shock, in this case) is indicated.



The \otimes symbol indicates a prohibited action. In this symbol the actual type of prohibited actions (disassembly, in this case) will be indicated.



The \bullet symbol indicates a restriction. In this symbol the type of actual restriction (removal of the power plug from an outlet, in this case) is indicated.

Warning!

Handling the register



Should the register malfunction, start to emit smoke or a strange odor, or otherwise behave abnormally, immediately shut down the power and unplug the AC plug from the power outlet. Continued use creates the danger of fire and electric shock.

- Contact CASIO service representative.



Do not place containers of liquids near the register and do not allow any foreign matter to get into it. Should water or other foreign matter get into the register, immediately shut down the power and unplug the AC plug from the power outlet. Continued use creates the danger of short circuit, fire and electric shock.

- Contact CASIO service representative.



Should you drop the register and damage it, immediately shut down the power and unplug the AC plug from the power outlet. Continued use creates the danger of short circuit, fire and electric shock.

- Attempting to repair the register yourself is extremely dangerous. Contact CASIO service representative.



Never try to take the register apart or modify it in any way. High-voltage components inside the register create the danger of fire and electric shock.

- Contact CASIO service representative for all repair and maintenance.

Power plug and AC outlet



Use only a proper AC electric outlet. Use of an outlet with a different voltage from the rating creates the danger of malfunction, fire, and electric shock. Overloading an electric outlet creates the danger of overheating and fire.



Make sure the power plug is inserted as far as it will go. Loose plugs create the danger of electric shock, overheating, and fire.

- Do not use the register if the plug is damaged. Never connect to a power outlet that is loose.

INTRODUCTION

Warning!



Use a dry cloth to periodically wipe off any dust built up on the prongs of the plug. Humidity can cause poor insulation and create the danger of electric shock and fire if dust stays on the prongs.



Do not allow the power cord or plug to become damaged, and never try to modify them in any way. Continued use of a damaged power cord can cause deterioration of the insulation, exposure of internal wiring, and short circuit, which creates the danger of electric shock and fire.

- Contact CASIO service representative whenever the power cord or plug requires repair or maintenance.

Caution!



Do not place the register on an unstable or uneven surface. Doing so can cause the register — especially when the drawer is open — to fall, creating the danger of malfunction, fire, and electric shock.



Do not place the register in the following areas.

- Areas where the register will be subject to large amounts of humidity or dust, or directly exposed to hot or cold air.
- Areas exposed to direct sunlight, in a close motor vehicle, or any other area subject to very high temperatures.

The above conditions can cause malfunction, which creates the danger of fire.



Do not overlay bend the power cord, do not allow it to be caught between desks or other furniture, and never place heavy objects on top of the power cord. Doing so can cause short circuit or breaking of the power cord, creating the danger of fire and electric shock.



Be sure to grasp the plug when unplugging the power cord from the wall outlet. Pulling on the cord can damage it, break the wiring, or cause short, creating the danger of fire and electric shock.



Never touch the plug while your hands are wet. Doing so creates the danger of electric shock. Pulling on the cord can damage it, break the wiring, or cause short, creating the danger of fire and electric shock.



At least once a year, unplug the power plug and use a dry cloth or vacuum cleaner to clear dust from the area around the prongs of the power plug.

Never use detergent to clean the power cord, especially power plug.



Keep small parts out of the reach of small children to make sure it is not swallowed accidentally.



Disposing of batteries:

Make sure that you dispose of used batteries in accordance with the rules and regulations in your local area.

Contents

Getting to know your cash register	6
Daily Job Flow	8
Part-1 QUICK START OPERATION	9
1. Loading Memory Protection Battery	9
2. Loading Paper Roll	9
3. Setting the Cash Register.....	10
4. If you want to use a printer as journal printer	10
5. To remove receipt paper	11
6. To remove journal paper	11
7. Caution (in handling the thermal printer)	11
8. Basic Programming for QUICK START	12
9. Basic Operation after Basic Programming.....	14
10. Daily Management Report.....	18
Part-2 CONVENIENT OPERATION.....	20
1. Various Programming	20
2. Various Operations	37
Part-3 CALCULATOR FUNCTION	43
1. Calculator Mode.....	43
Part-4 USEFUL INFORMATION.....	45
1. Troubleshooting	45
2. Specifications.....	46

Basic Components and Accessories

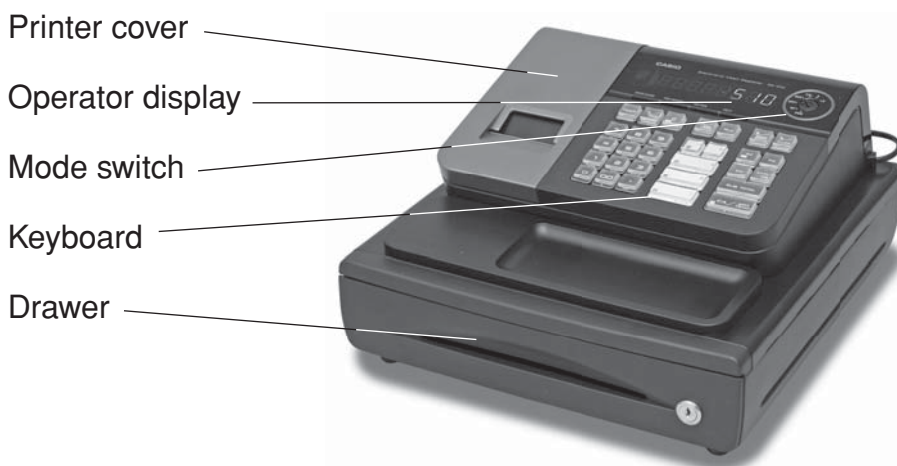

(SE-S10 small drawer model)

Accessories

Roll paper	1 pc
Mode keys	
Drawer keys	2 pcs
User's manual	1 pc
Fixing hook	
(M drawer model only)	2 pcs
Magnetic plate*	1 pc

* Use this plate for tacking the notes received from customer.

Weld lines

Lines may be visible on the exterior of the product. These are "weld lines" that result from the plastic molding process. They are not cracks or scratches.

Getting to know your cash register

Mode Switch

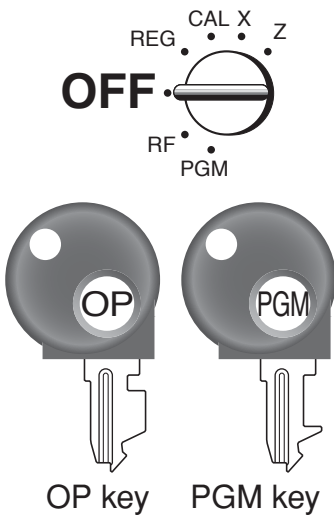

The position of the Mode Switch controls the type of operations you can perform on the cash register. The PROGRAM key (marked PGM) can be select any Mode Switch setting, while OPERATOR key (marked OP) can be used to select OFF, REG or CAL only.

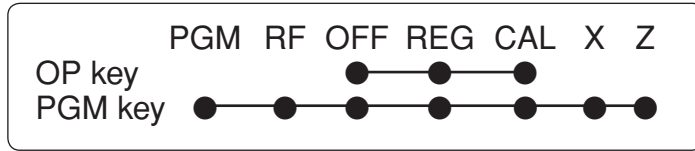

OFF

In this position, the power of the cash register is off.

REG (Register)

This is the position used for registration of normal transactions.

RF (Refund)

This is the position used for registration of refunds.

CAL (Calculator)

This is the position used for calculator mode.

PGM (Programming)

This is the position used to program the cash register to suit the needs of your store.

X (Read)

This is the position used to produce reports of daily sales totals without clearing the totals.

Z (Reset)

This is the position used to produce reports of daily sales totals. This setting clears the totals.

Note:

An error is generated (E01 displayed) whenever the position of the Mode Switch is changed during registration.

Display

Operator display

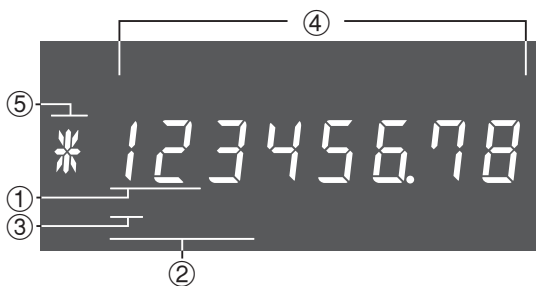

Customer display

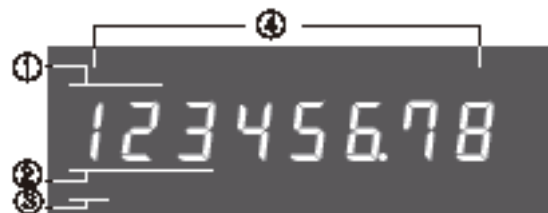

① Department Number Display

Anytime you press a department key to register a unit price, the corresponding department number appears here.

② PLU Number Display

Anytime you perform a PLU registration, the corresponding PLU number appears here.

③ Number of Repeat Display

Anytime you perform "repeat registration" (page 14), the number of repeats appears here. Note that only one digit is displayed for the number of repeats.

④ Numeric Display

Entered values (unit prices or quantities) and calculated values (subtotals, totals or change amount due) are displayed here. The capacity of the display is 8 digits.

This part of the display can be used to show the current time or date between registrations (page 40).

⑤ Character Display

In the character programming (P2) mode, it shows the last entered character.

The total (T) or change (C) appears when a subtotal, total, or change is obtained.

In the paper saving mode, it shows *.

Keyboard

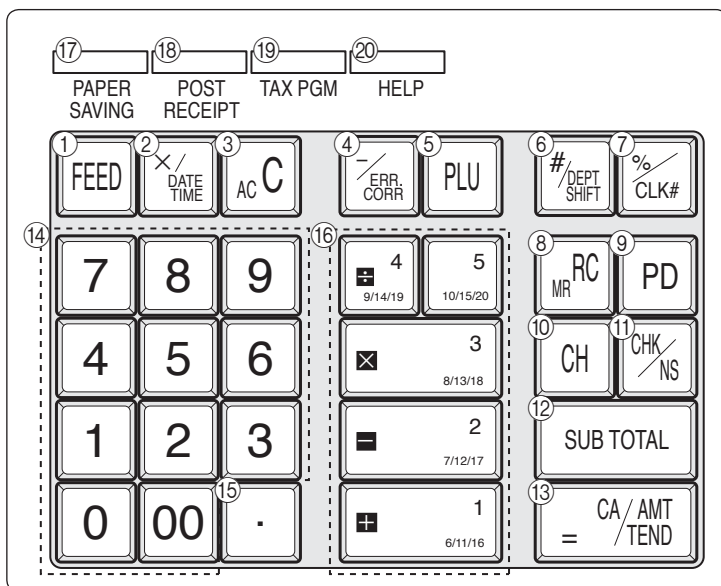

Certain keys have two functions; one for register mode and one for calculator mode.

In this manual, we will refer to specific keys as noted below to make the operations as easy to understand as possible:

Register Mode

- ① **FEED** Feed key
- ② **X/DATE TIME** Multiplication/ Date Time key
- ③ **AC C** Clear key
- ④ **-/ERR CORR** Minus/ Error Correction key
- ⑤ **PLU** PLU (Price Look Up) key
- ⑥ **#/DEPT SHIFT** Reference Number/Department Shift key
- ⑦ **%/CLK#** Percent/Cashier ID No. Assignment key
- ⑧ **RC/MR** Received on Account key
- ⑨ **PD** Paid Out key
- ⑩ **CH** Charge key
- ⑪ **CHK/NS** Check/No Sale key
- ⑫ **SUB TOTAL** Subtotal key
- ⑬ **= CA/AMT/TEND** Cash Amount Tendered key
- ⑭ **0, 1, ~ 9, 00** Numeric keys and 2-zero key
- ⑮ **.** Decimal key
- ⑯ **+1, -2, x3, ÷4, 5** Department keys

• Department 6 through 20 are specified by pressing the **#/DEPT SHIFT** key respectively as follows:

- #/DEPT SHIFT** + **1** ~ **#/DEPT SHIFT** + **5** → Department 6 ~ 10
- #/DEPT SHIFT** + **1** ~ **#/DEPT SHIFT** + **5** → Department 11 ~ 15
- #/DEPT SHIFT** + **1** ~ **#/DEPT SHIFT** + **5** → Department 16 ~ 20

⑰ **PAPER SAVING** Paper saving key

Paper saving key is the key to save printing paper (Journal compressed printing/ No receipt issuing). In these cases, "*" is lit on the character display.

⑱ **POST RECEIPT** Post receipt key

Post receipt key is used for issuing receipt after transaction. This key is effective if the printer is defined as printing receipts. Refer to page 38.

⑲ **TAX PGM** Tax Program key

⑳ **HELP** Help key

Help key is used for issuing assistant receipts such as programming date/ time, paper installation etc.

Calculator Mode

- ③ **AC c** AC key
- ⑦ **%/CLK#** Percent key
- ⑧ **RC/MR** Memory Recall key
- ⑪ **CHK/NS** Drawer Open key
- ⑬ **= CA/AMT/TEND** Equal key
- ⑭ **0, 1, ~ 9, 00** Numeric keys and 2-zero key
- ⑮ **.** Decimal key
- ⑯ **+1, -2, x3, ÷4** Arithmetic Operation key

Daily Job Flow

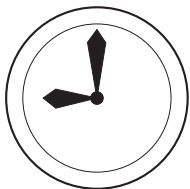

Before Opening The Store

1. Plugged in? Page-11
2. Enough Roll Paper? Page-40
3. Date and Time is correct? Page-41
4. Enough small change in the drawer? Page-41

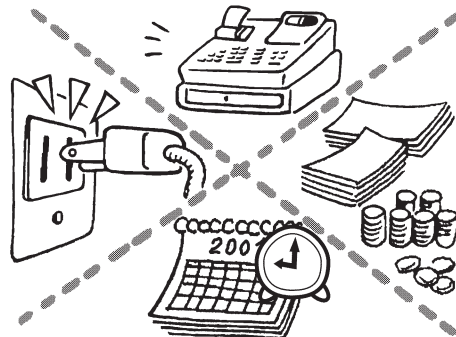

While The Store Is Open

1. Registrations. Page-14 ~
2. Issuing latest daily sales total if needed.
(Generating report by Mode Switch to X position.) Page-18

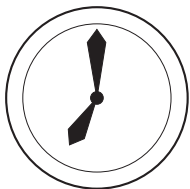

After Closing The Store

1. Issuing Daily Sales Total.
(Resetting report by Mode Switch to Z position.) Page-19
2. Picking up money in the drawer. Page-41.
Turn the Mode Switch to OFF.

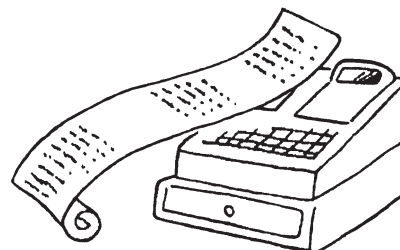

Other

1. Troubleshooting Page-45



QUICK START OPERATION

Part-1

1. Loading Memory Protection Battery

Important
You must initialize the Cash register.

1. Remove the printer cover.
2. Open the battery compartment cover.
3. Load 2 new UM-3, or R6P (SUM-3) type batteries into the compartment. Be sure that the plus (+) and minus (-) ends of each battery are facing in the directions indicated by the illustrations inside the battery compartment (Figure 1).
4. Replace the memory protection battery compartment cover back into place.



(Figure 1)

- **Note:** To prevent to lose all of your settings and sales data, we recommend you to install the memory protection batteries.
- **REPLACE MEMORY PROTECTION BATTERIES AT LEAST ONCE EVERY YEAR.**

2. Loading Paper Roll

To load receipt paper

- ① Open platen arm.



- ③ Put the leading end of the paper over the printer.



- ② Ensuring the paper is being fed from the bottom of the roll, lower the roll into the space behind the paper.



- ④ Close the platen arm slowly until it locks steadily.



CAUTION

RISK OF EXPLOSION IF BATTERY IS REPLACED BY AN INCORRECT TYPE.
DISPOSE OF USED BATTERIES ACCORDING TO THE INSTRUCTIONS.

3. Setting the Cash Register

- ① Plug the power cord of the cash register into AC outlet.
- ② Please choose your language followed by printed message.
- ③ When the display shows blinking "0", such as



Enter current date in Day, Month, Year.

- ④ When the display shows blinking "0", such as



Enter current time in Hour, Minute.

- ⑤ Set the mode switch to REG.
- ⑥ Tear off any excess paper.



- ⑦ Replace the printer cover slowly.



*Default printer definition is receipt printer.

4. If you want to use a printer as journal printer

- ① Set printing system as journal.

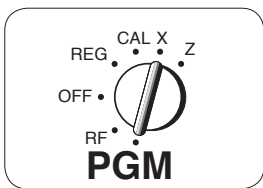

- 1 SUB TOTAL
- 1 CH

- ② Remove the printer cover by lifting up the back.



- ③ Press the FEED key until approximately 20cm of the paper is fed from the register.

- ④ Roll the paper onto the take up reel a few turns.



- ⑤ Set the left plate of the take up reel and place the reel into the register.
- ⑥ Press the FEED key to take up any slack in the paper.
- ⑦ Replace the printer cover slowly.



5. To remove receipt paper

- ① Open the platen arm.



- ② Remove the core of the paper.



6. To remove journal paper

- ① Remove the printer cover by lifting up the back.



- ② Press the **FEED** key until approximately 20cm of the paper is fed from the printer.

- ③ Cut off the roll paper.



- ④ Remove the take-up reel from the printer and take off the left plate of the reel.

- ⑤ Remove the journal paper from the take-up reel.



- ⑥ Open the platen arm.



- ⑦ Remove the core of the paper.



- ⑧ Load new paper following the instructions "1. To load journal paper".

7. Caution (in handling the thermal printer)

1. Never touch the printer head and platen.
2. Unpack the paper just before you use.
3. Avoid heat/ direct sunlight.
4. Avoid dusty and humid places for storage.
5. Do not scratch the paper.
6. Do not keep the paper under the following circumstances: High humidity and temperature/ direct sunlight/ contact with glue, thinner or rubber eraser.

8. Basic Programming for QUICK START

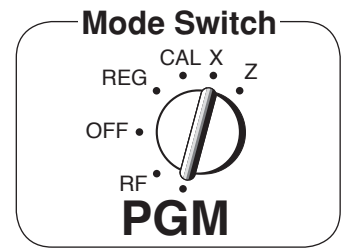

Procedure	Purpose												
<p>1. To select the date format and monetary mode (if necessary)</p> <p>You can select the date format and monetary mode after initialization depending on the requirements in your area. Default date format is Day/ Month/ Year and default monetary mode is add 2.</p> <div style="display: flex; justify-content: space-around; align-items: flex-start;"> <div style="text-align: center;"> <p>3 SUB TOTAL</p> <p>P3 appears in mode display</p> <p>0 1 2 2 SUB TOTAL</p> <p>Program set code No.</p> <p>2 0 = CA/AMT TEND</p> <p>Select number from list A →</p> <p>Select number from list B →</p> <p>SUB TOTAL</p> <p>(To end the setting)</p> </div> <div style="border: 1px solid black; padding: 5px;"> <p>Date Format Selections</p> <table border="1" style="width: 100%; border-collapse: collapse;"> <tr> <td style="width: 30px;">Year/ Month/ Day</td> <td style="width: 30px; text-align: center;">0</td> </tr> <tr> <td>Day/ Month/ Year</td> <td style="text-align: center;">1</td> </tr> <tr> <td>Month/ Day/ Year</td> <td style="text-align: center;">2</td> </tr> </table> <p>Monetary Mode Selections</p> <table border="1" style="width: 100%; border-collapse: collapse;"> <tr> <td style="width: 30px;">Add 0 (0.)</td> <td style="width: 30px; text-align: center;">0</td> </tr> <tr> <td>Add 1 (0.0)</td> <td style="text-align: center;">1</td> </tr> <tr> <td>Add 2 (0.00)</td> <td style="text-align: center;">2</td> </tr> </table> </div> </div>	Year/ Month/ Day	0	Day/ Month/ Year	1	Month/ Day/ Year	2	Add 0 (0.)	0	Add 1 (0.0)	1	Add 2 (0.00)	2	<p>Select date format and monetary mode</p>
Year/ Month/ Day	0												
Day/ Month/ Year	1												
Month/ Day/ Year	2												
Add 0 (0.)	0												
Add 1 (0.0)	1												
Add 2 (0.00)	2												
<p>2. Input the desired add-in tax rate to the appropriate department key.</p> <p>(This procedure below programs add-in tax rate only. If you want to set add-on tax or tax with special rounding, refer to page 27 of this manual.)</p> <p>A) Enter 1 and press the SUB TOTAL key.</p> <p>B) Press the TAX PGM key.</p> <p>C) Enter tax rate. (Example: For 6% enter “6”, 5.75% enter “5.75”.)</p> <p>D) Press the appropriate department key.</p> <p>E) Repeat step B) and C) to set other department key.</p> <p>F) Press the SUB TOTAL key to end tax programming.</p> <p>Note: In case of setting the wrong tax rate to the key, please enter 0 and press those department keys above, and quit this procedure by pressing SUB TOTAL key, and start from the beginning of this procedure.</p> <p>Example :</p> <p>Set add-in tax 8% to department 2, 3, 15% to department 4 key.</p> <div style="margin-left: 20px;"> <p>TAX PGM Start tax program.</p> <p>8 - 2 Enter tax rate and press dept key.</p> <p>8 × 3 Enter tax rate and press dept key.</p> <p>1 5 ÷ 4 Enter tax rate and press dept key.</p> <p>SUB TOTAL To end the setting.</p> </div>	<p>Setting the tax rates</p>												

Procedure	Purpose
<p>3. In case of accepting two (the Euro and the local) currencies.</p> <p>3-1. Press the following keys to define the main currency/print out currency of the subtotal.</p> <p>3 <input type="button" value="SUB TOTAL"/></p> <p>P3 appears in mode display</p> <p>2 4 2 2 <input type="button" value="SUB TOTAL"/></p> <p>1 <input type="button" value="CA/AMT TEND"/></p> <p>Euro Status</p> <p><input type="button" value="SUB TOTAL"/></p> <p>(to end the setting)</p> <p>Euro status</p> <p>(1) Main currency = Local, Print out subtotal = Local: 0</p> <p>(2) Main currency = Euro, Print out subtotal = Euro : 1</p> <p>(3) Main currency = Local, Print out subtotal = Both: 2</p> <p>(4) Main currency = Euro, Print out subtotal = Both : 3</p> <p>3-2. Press the following keys to set the currency exchange rate against the Euro.</p> <p>1 <input type="button" value="SUB TOTAL"/></p> <p>P appears in mode display</p> <p>1 . 5 9 <input type="button" value="PD"/></p> <p><input type="button" value="SUB TOTAL"/></p> <p>(To end the setting)</p> <p>Example: (Exchange rate and decimal position)</p> <p>Currency exchange rate = 1 Euro in local currency</p> <p>1 Euro = 1.95583 DM : 1 9 5 5 8 3 5</p> <p>· The rate within the range of 0.00001 to 999999.</p>	<p>Setting the Euro</p>
<p>4. In case of becoming to accept the Euro only.</p> <p>You can restrict the registrable currency to the Euro only by the following procedure.</p> <p>1. Turn the mode switch to Z position.</p> <p>2. Issue all reset report including periodic data.</p> <p>3. Press the following keys to set. 0 1 0 7 2 0 0 2 <input type="button" value="SUB TOTAL"/> <input type="button" value="CA/AMT TEND"/></p> <p>If you want to cancel this operation, press <input type="button" value="SUB TOTAL"/> instead of <input type="button" value="CA/AMT TEND"/>.</p>	<p>Restricting the Currency to the Euro</p>
<p>5. For Australia only.</p> <p>You can set some programmable options to suit the Australian GST by the following procedure.</p> <p>1. Turn the mode switch to Z position.</p> <p>2. Press the following keys to program. 0 1 0 1 2 0 0 1 <input type="button" value="SUB TOTAL"/> <input type="button" value="CA/AMT TEND"/></p> <p>If you want to cancel this operation, press <input type="button" value="SUB TOTAL"/> instead of <input type="button" value="CA/AMT TEND"/>.</p>	<p>Setting the Australian GST</p>

9. Basic Operation after Basic Programming

Note:

Whenever an error is generated, the input figures reset to 0. All printout samples are journal images and the header (date, time and consecutive no.) are eliminated from the samples.

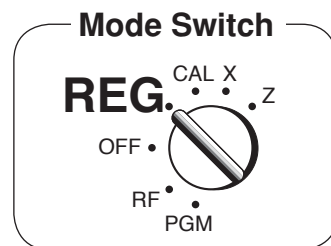

9-1 Open the drawer without a sale

CHK/NS	08-01-2010	08:55
	REG	0001
	NS No Sale Symbol

9-2 Basic operation

Example

Unit Price	\$1.00	\$2.00	\$0.30
Quantity	1	1	1
Dept.	1	10	15
Cash Amount tendered	\$5.00		

1 0 0 + 1 (6/11/16)
Unit Price Department 1

#/DEPT SHIFT 2 0 0 5 (10/15/20)
Department 10

#/DEPT SHIFT #/DEPT SHIFT 3 0 5 (10/15/20)
Department 15

SUB TOTAL
5 0 0 = CA/AMT/TEND

Cash amount tendered

08-01-2010	09:00
REG	0002
DEPT01	· 1.00 — Department No./Unit Price
DEPT10	· 2.00
DEPT15	· 0.30
TOTAL	· 3.30 — Subtotal
CASH	· 5.00 — Cash Amount Tendered
CHANGE	· 1.70 — Change Amount Due

Departments 6 through 10, 11 through 15, 16 through 20 can also be registered in combination with the #/DEPT SHIFT and + 1 (6/11/16), - 2 (7/12/17), x 3 (8/13/18), + 4 (9/14/19) or 5 (10/15/20) keys, respectively. The #/DEPT SHIFT key should be entered just before entering unit price manually.

9-3 Multiple registration of the same items

Example

Unit Price	\$1.00	\$1.35
Quantity	2	3
Dept.	1	2

1 0 0 + 1 (6/11/16)
Department 1

Unit Price + 1 (6/11/16)

Quantity 3 x/DATE TIME

Multiple key

1 3 5 - 2 (7/12/17)

SUB TOTAL
CA/AMT/TEND

08-01-2010	09:05
REG	0003
DEPT01	· 1.00
DEPT01	· 1.00 — Repeat
3 X @ 1.35	· 4.05 — Sales Quantity/ Unit Price
DEPT02	· 4.05
CASH	· 6.05

Note that repeat registration can be used with unit prices up to 6 digits long.

9-4 Charge sales

Example

Unit Price	\$1.00	\$2.00	\$3.00
Quantity	1	1	1
Dept.	1	2	1

1 0 0 + 1 (6/11/16)

2 0 0 - 2 (7/12/17)

3 0 0 + 1 (6/11/16)

SUB TOTAL
CH

Charge key

08-01-2010	09:10
REG	0004
DEPT01	· 1.00
DEPT02	· 2.00
DEPT01	· 3.00
CHARGE	· 6.00 — Charge Sales

You cannot perform the amount tendered operation using the CH key.

9-5 Split cash/ charge sales

Example

Unit Price	\$2.00	\$3.00	\$4.00
Quantity	1	1	1
Dept.	1	2	1
Cash Amount tendered	\$5.00		

Operation	Printout																
<p>2 0 0 + 1 3 0 0 - 2 4 0 0 + 1 5 0 0 = CA/AMT/TEND CH</p>	<table border="1"> <tr> <td>08-01-2010</td> <td>09:25</td> </tr> <tr> <td>REG</td> <td>0005</td> </tr> <tr> <td>DEPT01</td> <td>·2.00</td> </tr> <tr> <td>DEPT02</td> <td>·3.00</td> </tr> <tr> <td>DEPT01</td> <td>·4.00</td> </tr> <tr> <td>TOTAL</td> <td>·9.00</td> </tr> <tr> <td>CASH</td> <td>·5.00 — Cash Amount Tendered</td> </tr> <tr> <td>CHARGE</td> <td>·4.00 — Charge Sales</td> </tr> </table>	08-01-2010	09:25	REG	0005	DEPT01	·2.00	DEPT02	·3.00	DEPT01	·4.00	TOTAL	·9.00	CASH	·5.00 — Cash Amount Tendered	CHARGE	·4.00 — Charge Sales
08-01-2010	09:25																
REG	0005																
DEPT01	·2.00																
DEPT02	·3.00																
DEPT01	·4.00																
TOTAL	·9.00																
CASH	·5.00 — Cash Amount Tendered																
CHARGE	·4.00 — Charge Sales																

9-6 Corrections

9-6-1 Before you press a department key

Corrections can be made while you are registering the item (before you press a department key), or after it has already been registered into the memory (by pressing a department key).

AC C key clears the last item entered.

Example

- Entered 400 for unit price by mistake instead of 100.

Operation	Printout		
<p>4 0 0 AC C Wrong entry Clears the last item entered.</p> <p>1 0 0 + 1 Correct entry Registered Department 1</p>	<table border="1"> <tr> <td>DEPT01</td> <td>· 1.00</td> </tr> </table>	DEPT01	· 1.00
DEPT01	· 1.00		

- Entered unit price first instead of quantity and then pressed **X/DATE TIME**.

<p>2 0 0 X/DATE TIME Unit price Multiplication</p> <p>AC C Clears the last item entered.</p> <p>5 X/DATE TIME Quantity Multiplication</p>	<table border="1"> <tr> <td>5 X @2.00</td> </tr> <tr> <td>DEPT02 · 10.00</td> </tr> </table>	5 X @2.00	DEPT02 · 10.00
5 X @2.00			
DEPT02 · 10.00			

- Entered 150 for unit price by mistake instead of 105.

<p>1 0 X/DATE TIME Quantity Multiplication</p> <p>1 5 0 AC C Wrong entry Clears the last item entered.</p> <p>1 0 X/DATE TIME Quantity</p> <p>1 0 5 x 3 Correct entry Registered Department 3</p>	<table border="1"> <tr> <td>10 X @1.05</td> </tr> <tr> <td>DEPT03 · 10.50</td> </tr> </table>	10 X @1.05	DEPT03 · 10.50
10 X @1.05			
DEPT03 · 10.50			

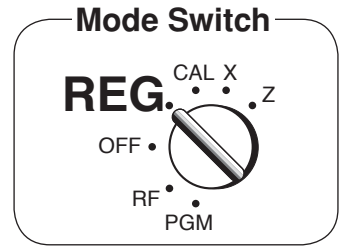

9-6-2 After you pressed a department key

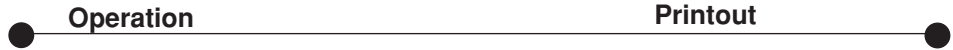

Example

- Entered unit price 550 by mistake instead of 505 and pressed a department key.

key cancels the last registered item.

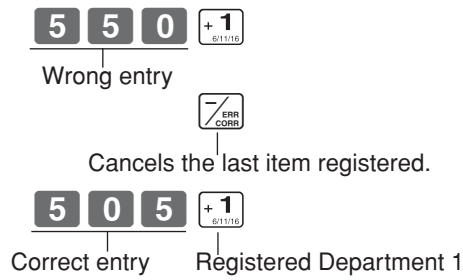

DEPT01	· 5.50
ERR CORR	-5.50
DEPT01	· 5.05

- Entered unit price 220 by mistake instead of 230 and pressed a department key.

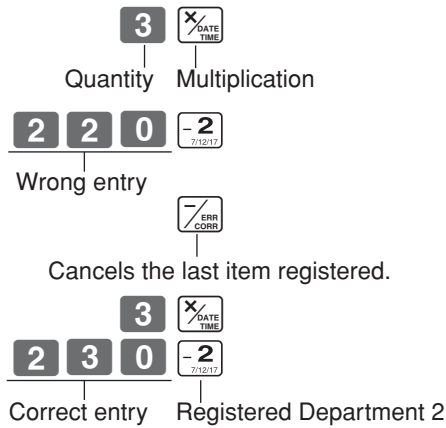

3 x	@2.20
DEPT02	· 6.60
ERR CORR	-6.60
3 X	@2.30
DEPT02	· 6.90

9-7 Registering with currency exchange

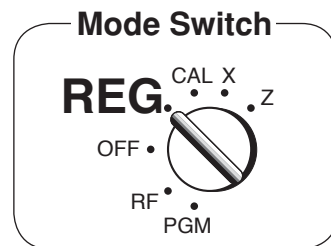

Example

Unit Price	£2.00
Quantity	3
Dept. 1	1
Cash Amount tendered	10.00 Euro
Rate	1Euro = £ 0.8
Main currency	Local (£)
Printout of ST	Both currencies

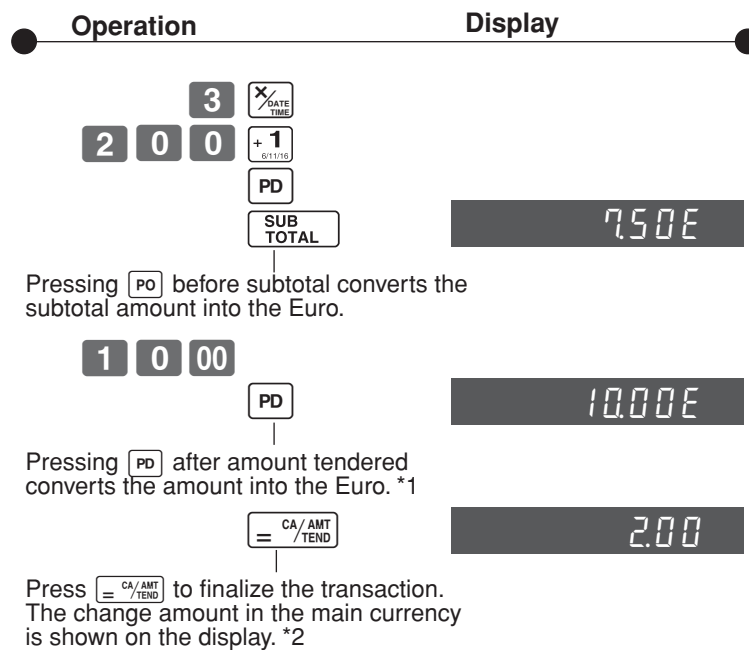

- *1 If the payment is the same as the subtotal amount, you can omit this operation. Press key directly after the subtotal.
- *2 If the payment is less than the subtotal amount, the cash register specifies it as a partial payment and shows the balance in the main currency on the display.

Printout

08-01-2010	09:30	
REG	0010	
3 x	@2.00	
DEPT01	·6.00	
TOTAL	·6.00	Subtotal in the main currency
	€7.50	Subtotal after conversion
EURO		Payment in the Euro
CASH	€10.00	
CASH	·8.00	Payment after conversion
CHANGE	·2.00	Change in the main currency
EURO CG	€2.50	Change in the sub currency

10. Daily Management Report

This section tells you the procedures to use to produce reports of the transaction data stored in the cash register's memory.

Important

Remember that when you issue a reset (Z) report, the data that is reported is cleared from the applicable totalizers. To view data without clearing totalizers, issue a read (X) report.

10-1 Financial Report

Operation

Printout

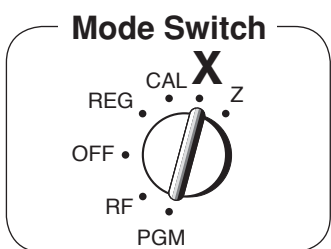

08-01-2010	19:10		
X	0070		
FLASH		X	Read Symbol
GROSS TOTAL	QT	57	Gross Sales No. of items
		·270.48	Gross Sales Amount
NET TOTAL	No	38	Net Sales No. of Customers
		·271.24	Net Sales Amount
CASH- INDW		·197.57	Cash Total in Drawer
CHARGE- INDW		·18.19	Charge Total in Drawer
CHECK- INDW		·45.18	Check Total in Drawer

10-2 Read/Reset Report

10-2-1 Electronic Journal Report

Mode Switch to **X**

Operation

Printout

5 8 = CA/AMT/TEND

(Date)*

= CA/AMT/TEND

(Consecutive No.)*

= CA/AMT/TEND

10-01-2010	19:25		
X	0173		
0058	EJ	X	Read Symbol
REG		17:34	Journal
		0023	
DEPT01		·2.24	
CA		·2.24	

* If you want to designate read range, enter date and/ or cosecutive No..

If you want to reset the electronic journal, just press **5 8** = CA/AMT/TEND in Z mode.

- Journal is saved in the memory and you can take a report any time you want.

10-2-2 Daily Read/Reset Report

Operation

Printout

Mode Switch to **(X)** (Read)

Mode Switch to **(Z)** (Reset)

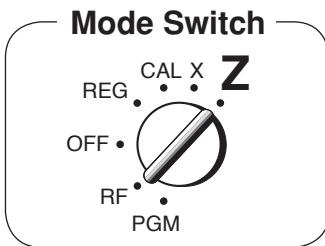

Z (Reset) report

08-01-2010	19:25	Date/Time
Z	0073	Consecutive No.
0000 DAILY	Z 0012	Non-resettable No. of Resets ¹ /RESET Symbol ¹
DEPT01	QT 48	Dept. Name/ No. of Items
	·50.10	Amount
DEPT02	QT 28	
	·76.40	
DEPT03	QT 17	
	·85.80	
DEPT04	QT 4	
	·0.00	

GROSS TOTAL	QT 108	Gross Sales No. of Items
	·316.80	Gross Sales Amount
NET TOTAL	No 46	Net Sales No. of Customers
	·325.13	Net Sales Amount
CASH- INDW	·199.91	Cash in Drawer
CHARGE- INDW	·16.22	Charge in Drawer
CHECK- INDW	·105.00	Check in Drawer
TA1	·105.10	Taxable Amount for Tax Rate 1
TAX1	·4.20	Tax Amount for Tax Rate 1
ROUNDING AMT	·1.23	Rounded Amount
RF-MODE TTL	No 2	Refnd Mode Count
	·0.50	Refund Mode Amount
CALCULATOR	No 3	No. of key operation in CAL mode

CASH	No 44	Cash Sales Count
	·203.91	Cash Sales Amount
CHARGE	No 3	Charge Sales Count
	·16.22	Charge Sales Amount
CHECK	No 2	Check Sales Count
	·105.00	Check Sales Amount
RC	·6.00	Received On Account Amount
PD	·10.00	Paid Out Amount
-	·0.50	Reduction Amount
%-	·0.66	Premium/Discount Amount
ERR CORR	No 21	Error Correction Count
NS	No 12	No sale Count

CLERK01	·325.13	Clerk 1 Sales Amount (Refer to 2-8 Cashier Assignment)

GT	·0,000,832,271.20	Non-resettable Grand Sales total (Printed only on RESET report) ²

X (Read) report is the same except ¹ and ².

10-2-3 Periodic Read/Reset Report

Operation

Printout

Mode Switch to **(Z)** or **(X)**



12-01-2010	20:25	
Z	1100	Periodic Reset Symbol
0010 PERIODIC	ZZ 0001	Gross Sales No. of Items
		Gross Sales Amount
GROSS TOTAL	QT 67	Net Sales No. of Customers
	·270.73	Net Sales Amount
NET TOTAL	No 38	
	·271.24	

Part-1



CONVENIENT OPERATION

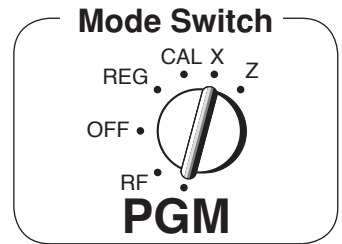

1. Various Programming

1-1 Unit price for Departments

Example

Unit Price	\$1.00	\$2.20	\$11.00
Dept.	1	2	3

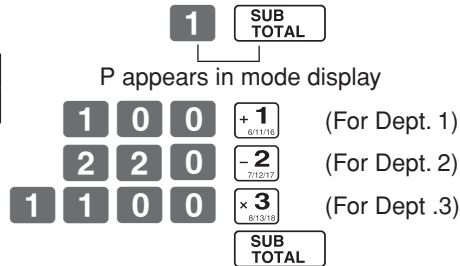

• Unit prices within the range of 0.01~9999.99.

1-2 Rate for percent key

Example

Discount Rate	2.5%
---------------	------

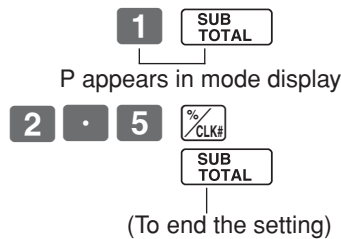

• The rate within the range of 0.01 to 99.99%.

1-3 To change tax status for Departments

Tax status for the Departments 1 ~ 20 are initialized as Non-Taxable.

Example

Status	Taxable 1	Taxable 2
Depts.	1	7

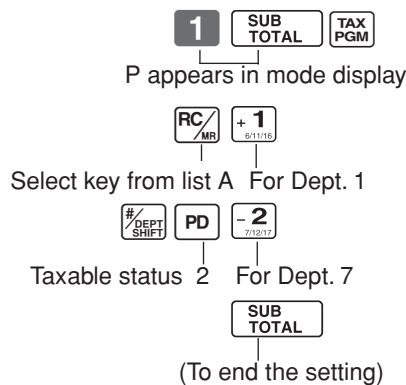

Selections	
Taxable status 1	RC/MR
Taxable status 2	PD
Taxable status 3	X/DATE TIME
Taxable status 4	CH
Non-taxable status	CHK/NS

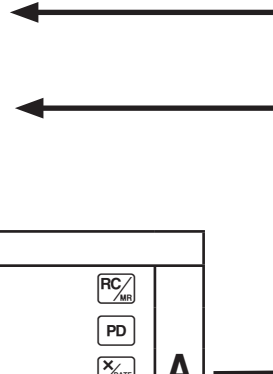

1-4 Status for Department

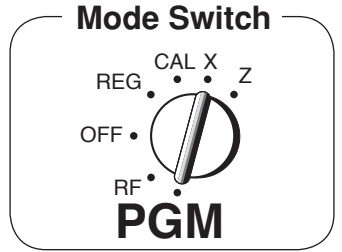

Example

Depts.	Selections		
	A	B	C
1	0	4	1
2	0	5	1

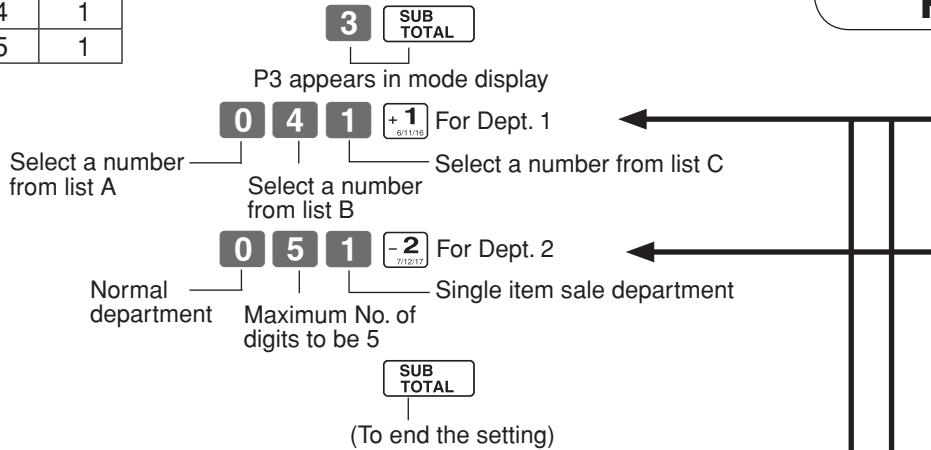

Selections		
Normal department	0	A
Minus department	1	
No limitation for manually entered price.(7digits)	0	B
Maximum number of digits for manually entered price. (1 ~ 7 digits)	1 ~ 7	
To prohibit manual price entries.	8 or 9	
Normal sales (not a single-item sale) department	0	C
Set as a single-item sale department	1	

1-5 Status for percent key

1-5-1 To change taxable status for the percent key The percent key is initialized as Non-taxable.

Example

Change Percent key registration as a Taxable status 1.

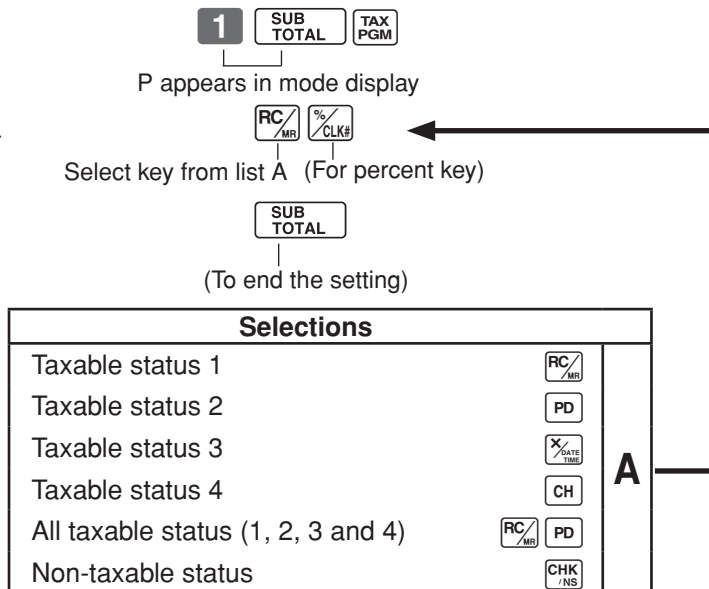

Part-2

Part-2 CONVENIENT OPERATION

1-5-2 Status for percent key

Example

Round	Up
Percent	%+

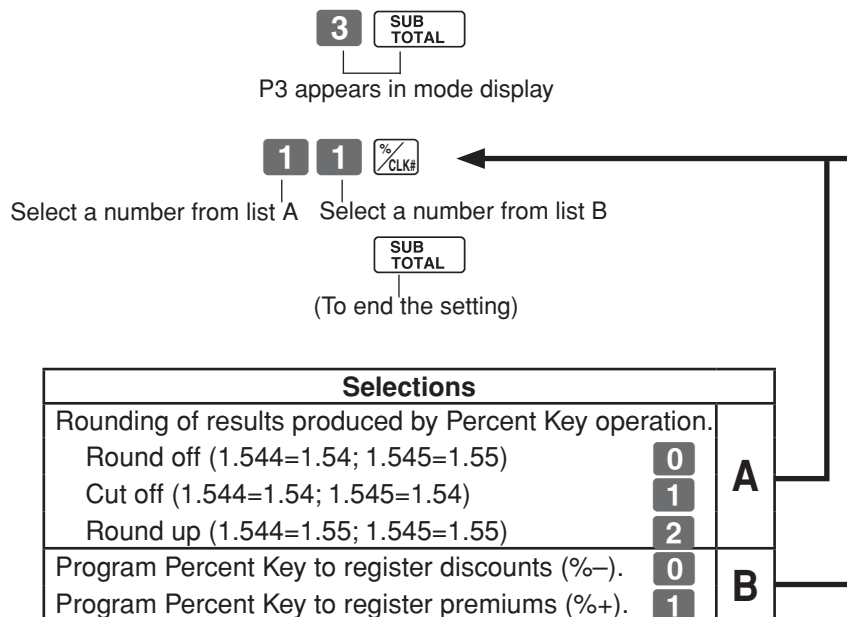

1-6 Taxable Status for minus key

The minus key is initialized as Non-taxable.

Example :

Change minus key registrations as a Taxable status 1.

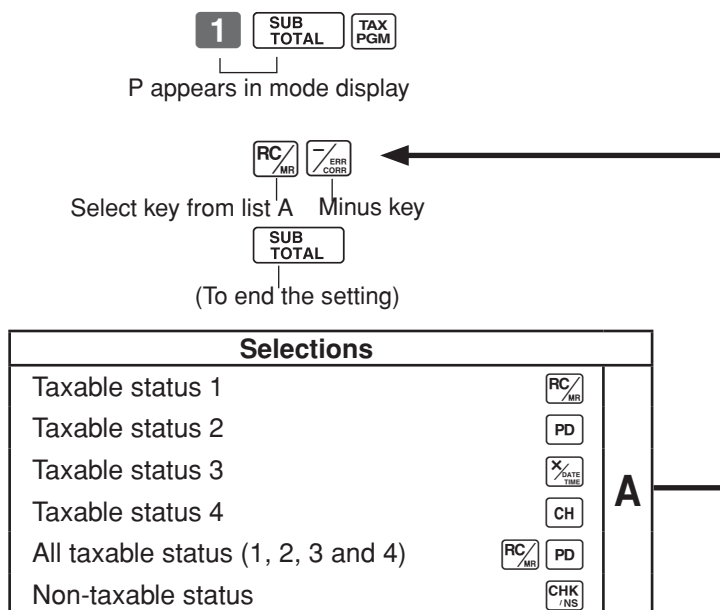

1-7 General features

1-7-1 To set general controls

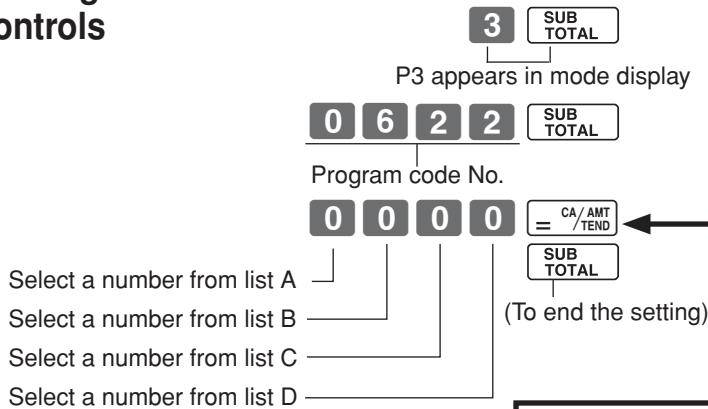
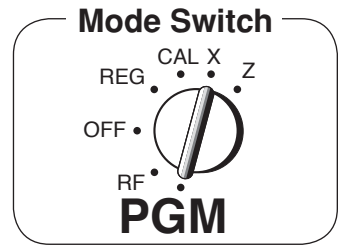

Selections			
Limit the last 2 digits of total amount to 00 and 50 when Danish rounding is specified for subtotal and total amount.			
Key catch tone.			
Yes	No	0	A
	Yes	2	
No	No	4	
	Yes	6	

Selections				
Maintain key buffer during receipt issue in REG mode.				
Reset the consecutive number to zero whenever a Daily Reset Report is issued.				
Allow credit balance registration.				
No	Yes	Yes	B	
		No		0
	No	Yes		1
		No		2
Yes	Yes	Yes	B	
		No		3
	No	Yes		4
		No		5

Selections				
Time displays with second.				
Allow split cash amount tendered.				
Allow split check amount tendered.				
Yes	Yes	No	C	
		Yes		0
	No	No		1
		Yes		2
No	Yes	No	C	
		Yes		3
	No	No		4
		Yes		5

Selections				
Use the 00 key as a 000 key.				
Cashier assignment systems (sign on) is used.				
Limit the last 1 digit of total amount to 0 and 5 when Malaysian rounding is specified for subtotal and total amount.				
No	No	No	D	
		Yes		0
	Yes	No		1
		Yes		2
Yes	No	No	D	
		Yes		3
	Yes	No		4
		Yes		5

Part-2 CONVENIENT OPERATION

1-7-2 To set printing controls

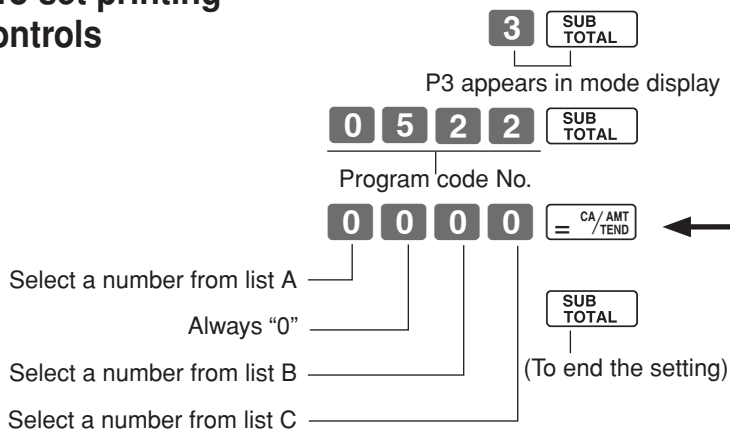

Selections			
Use the printer to print receipts = R			
Use the printer to print a journal = J			
Print receipt by single/ double height characters.			
Print Total line at finalization			
No	Single	R	0
		J	1
Yes	Double	R	2
		J	3
No	Single	R	4
		J	5
Yes	Double	R	6
		J	7

Selections	
Print the time on the receipt and journal.	
Yes	0
No	4

Selections			
Print the consecutive number on the receipt/journal.			
Print the subtotal on the receipt/ journal when the Subtotal Key is pressed.			
Skip item print on journal.			
No	No	Yes	0
		No	1
Yes	Yes	Yes	2
		No	3
No	No	Yes	4
		No	5
Yes	Yes	Yes	6
		No	7

1-7-3 To set report printing controls

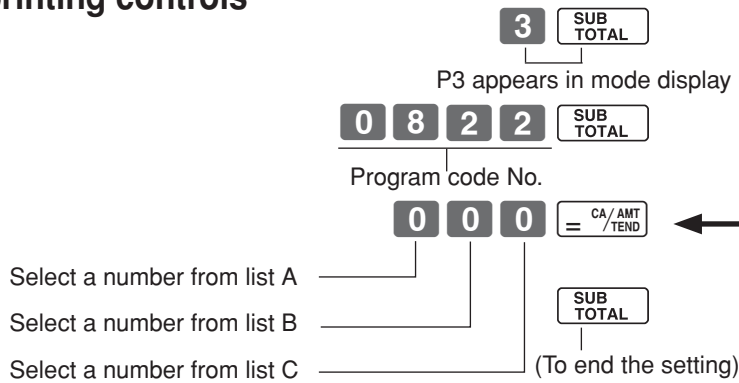
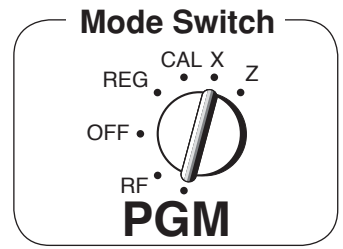

Selections	
Clear electronic journal memory after Daily Reset Report.	
Yes	0 A
No	1

Selections	
Print RF switch mode refund count/ amount on the Daily Read/Reset Reports.	
Yes	0 B
No	1

Selections	
Print zero-total line on the Read/Reset Reports	
Print the grand sales total on the Reset Reports.	
Yes	No 0 Yes 1 C
No	No 2 Yes 3

1-7-4 Printer switch for Receipt or Journal

The printer is initialized as receipt.

Example
To print a journal

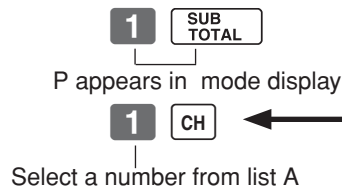

Selections	
Use the printer to print receipts.	0 A
Use the printer to print a journal.	1

•Printer selection to print a journal or receipts can also be set on procedures 1-7-2 "To set printing controls".

1-7-5 Receipt printing character/ key catch tone

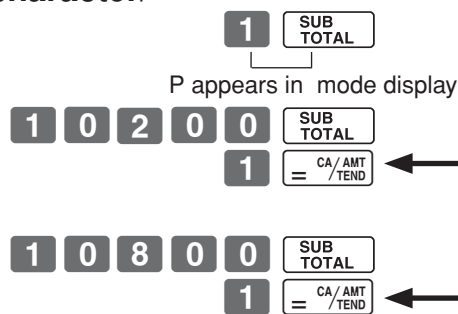

Selections	
Print receipt with single height.	0 A
Print receipt with double height.	1

Selections	
Key catch tone	0 B
No key catch tone	1

Part-2

1-8 PLU setting

1-8-1 Linkage with Departments

Example

PLU No.	1	100
Link dept. No.	4	4

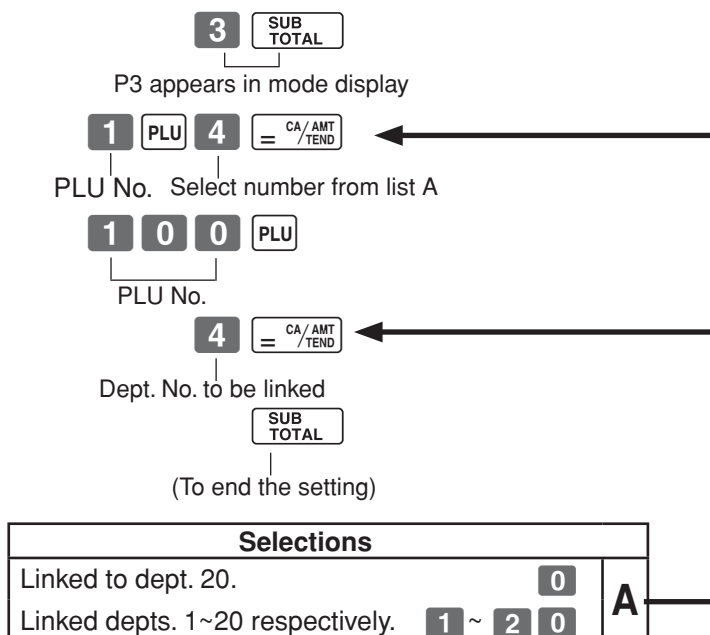

- 500 PLUs can be set.
- When the linked department is not specified, the PLU is linked to department 20.
- Status for a single-item sale and tax status are followed the specified linked department.

1-8-2 Unit Prices for PLUs

Example

PLU No.	1	2
Unit Price	\$1.00	\$3.00

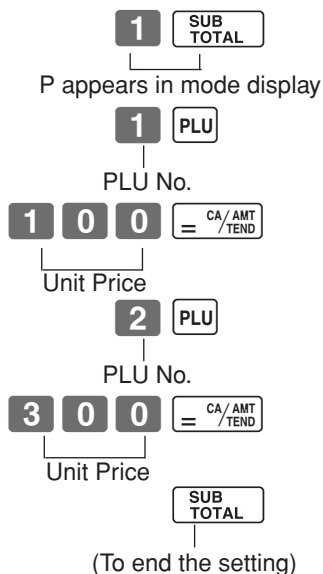

- Unit prices within the range of \$0.01~9999.99.

1-9 Setting the Tax Rate and rounding

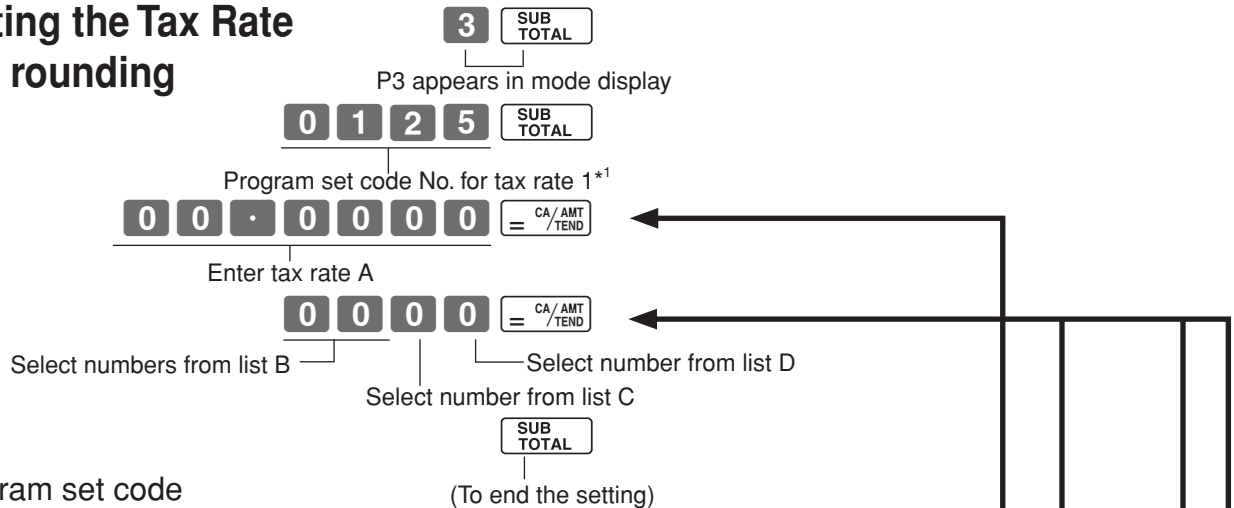

*1 Program set code No. for Tax rate 2 is

0 2 2 5

Tax rate 3 is

0 3 2 5

Tax rate 4 is

0 4 2 5

• You can use either an add-on rate tax or an add-in rate tax (VAT), depending on the requirements in your area. You can specify only one tax rate.

• The normal rounding specification tells the cash register how to round tax amounts to the proper number of decimal places.

• The special rounding specification and Danish rounding tell the cash register how to round off subtotals and totals so that their rightmost 2 digits are 00 and 50.

• Note that the rounding specification you program for your cash register depends on the tax laws of your country.

Tax rate specifications	
The tax rate within the range of 0.0001 ~ 99.9999%. Use . key for decimal point.	A

Normal rounding specifications	
Cut off to 2 decimal places. (1.544=1.54; 1.545=1.54)	0 0
Round off to 2 decimal places. (1.544=1.54; 1.545=1.55)	5 0
Round up to 2 decimal places. (1.544=1.55; 1.545=1.55)	9 0

Special rounding specifications for subtotal and total amounts	
No specifications	0
Special rounding 1: 0 ~ 2 → 0; 3 ~ 7 → 5; 8 ~ 9 → 10 Examples: 1.21=1.20; 1.26=1.25; 1.28=1.30	1
Special rounding 2: 0 ~ 4 → 0; 5 ~ 9 → 10 Examples: 1.123=1.120; 1.525=1.530	2
Danish rounding ^{*2} : 0 ~ 24 → 0; 25 ~ 74 → 50; 75 ~ 100 → 100 (set the amount tender restriction on page 23 also) Examples: 1.11=1.00; 1.39=1.50; 1.99=2.00	3
Malaysian rounding: 0 ~ 2 → 0; 3 ~ 7 → 5; 8 ~ 9 → 10 (set the amount tender restriction on page 23 also) Examples: 1.21=1.20; 1.26=1.25; 1.28=1.30	5
Scandinavian rounding: 0 ~ 24 → 0; 25 ~ 74 → 50; 75 ~ 99 → 100 Examples: 1.21=1.00; 1.30=1.50; 1.87=2.00	6
Australian rounding (only for tax rate 1) 0 ~ 2 → 0; 3 ~ 7 → 5; 8 ~ 9 → 10 Examples: 1.21=1.20; 1.26=1.25; 1.28=1.30	7
Czech rounding: 0 ~ 49 → 00; 50 ~ 99 → 100 Examples: 1.23=1.00; 1.52=2.00	8

Normal rounding specifications	
No specifications.	0
Specifies add-on rate tax.	2
Specifies add-in rate tax (VAT).	3

Part-2

See page 20 (department key), 21 (percent key), 22 (minus key) to change the fixed tax status.
*2: In case of defining Danish rounding, the Euro should be set to the sub currency and the local to the main currency.

Part-2 CONVENIENT OPERATION

1-10 To control Tax Status printing

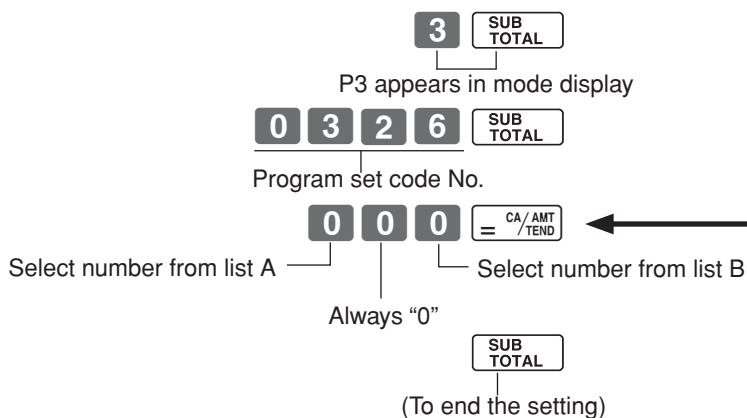
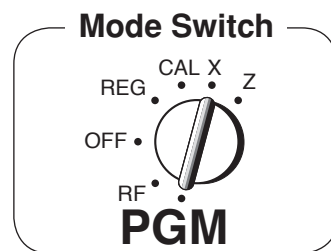

Selections		
Print tax total line (only for Australia).		
Print tax symbol.		
No	No	0
	Yes	1
Yes	No	2
	Yes	3

A

Selections		
Print taxable amount.		
Print taxable amount and tax amount for Add-in.		
No	No	0
	Yes	1
Yes	No	2
	Yes	3

B

1-11 To program department, PLU, clerk name, receipt message

1-11-1 Simple character list for HELP You can set department and PLU name by using a simple character list for HELP

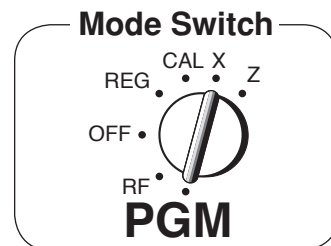

1-1. Issue category list.

1 2 HELP

112:ARTICLE SALE
212:BOOK, STATIONARY
312:ELECTRONIC GOODS
412:DRESSING
512:SERVICE
612:PHARMACY
712:FOODSTUFFS
812:MEAL
912:OTHER

Categories

1-2. Issue category list.

4 1 2 HELP

DRESSING
401: JEWELRY
402: CLOTHING
403: UMBRELLA
404: SHOES
: :
: :
428: SCARF

2-1. Programming department name.

Example

Department	2	8
Name	JEWELRY	SHOES
Character code	401	404

2 SUB TOTAL
P2 appears in mode display

4 0 1 -2 712117

4 0 4 #/DEPT SHIFT x 3 813116

SUB TOTAL
(To end the setting)

Part-2

2-2. Reset department name.

Department	2
Name	DEPT01
Character code	0

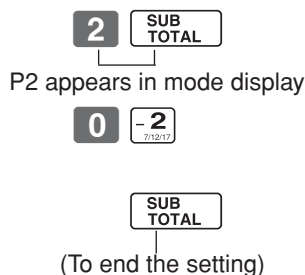

2-3. Programming department PLU

PLU(1-1200)	2	30
Name	CLOTHING	UMBRELLA
Character code	402	403

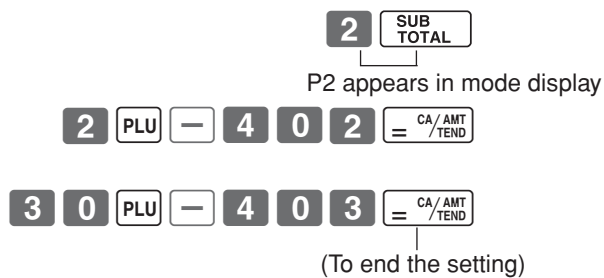

2-4. Reset PLU name.

PLU(1-1200)	30
Name	PLU0030
Character code	0

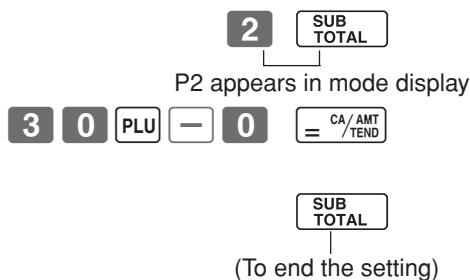

1-11-2 Character keyboard

In the PGM 2 mode, the keyboard becomes character setting keyboard illustrated below after specifying a department, a PLU, or a clerk.

- ① Double size key
Use this key to specify the next character to a double sized character. You must press this key before each double sized character.
- ② Alphabet keys
Use these keys to input characters. Refer to the next page to enter characters.
- ③ Right arrow key
Use this key to input the character located on the same alphabet key. This key is also used for inputting a space.
- ④ Delete key
Use this key to delete character just entered.
- ⑤ PLU key
Use this key to input PLU code.
- ⑥ Department keys
Use this key to specify department.
- ⑦ Department shift key
Use this key to shift department.
- ⑧ Clerk number key
Use this key to input clerk number.

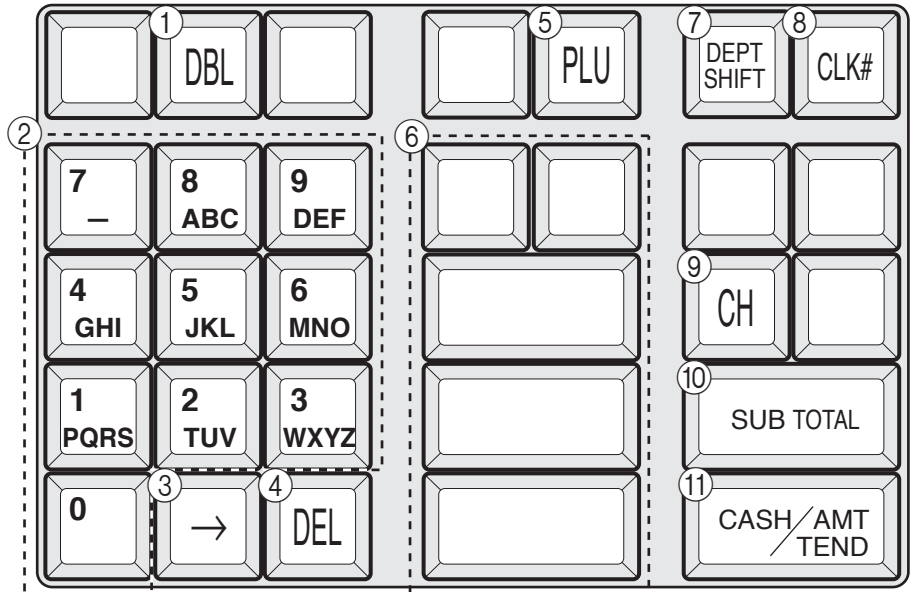

- ⑨ Receipt message number key (CH key).
Use this key to program receipt message.
- ⑩ Program end key (SUB TOTAL key)
Use this key to terminate character programming.
- ⑪ Character program key (CA/AMT TEND key)
Use this key to program the PLU / clerk characters just entered before.

1-11-3 Programming department name

Example

Department	1	7
Name	DAIRY	I-HBA

up to 8 (4 double sized) characters

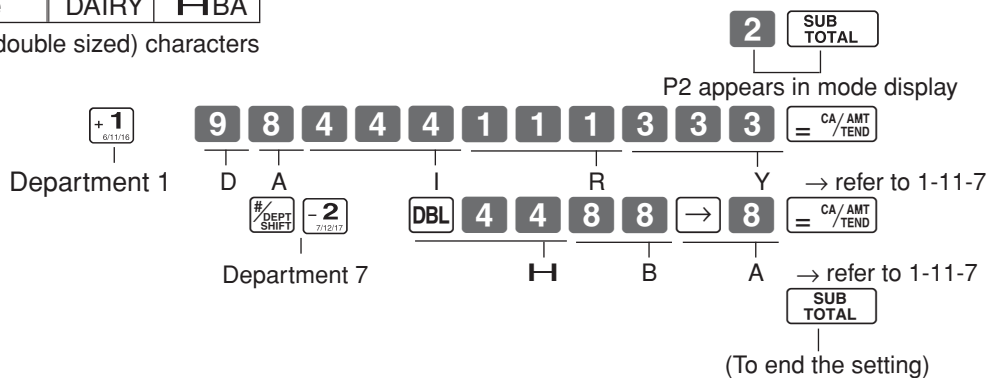

Part-2 CONVENIENT OPERATION

1-11-4 Programming PLU name

Example

PLU (1 ~ 500)	1	50
Name	DAIRY	HBA

up to 8 (4 double sized) characters

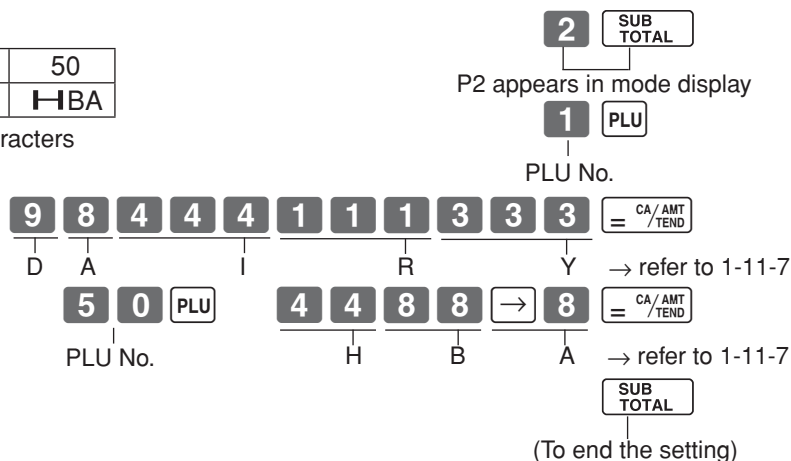

1-11-5 Programming clerk name

Example

Clerk (1~ 8)	1	5
Name	JOHN	KATE

up to 8 (4 double sized) characters

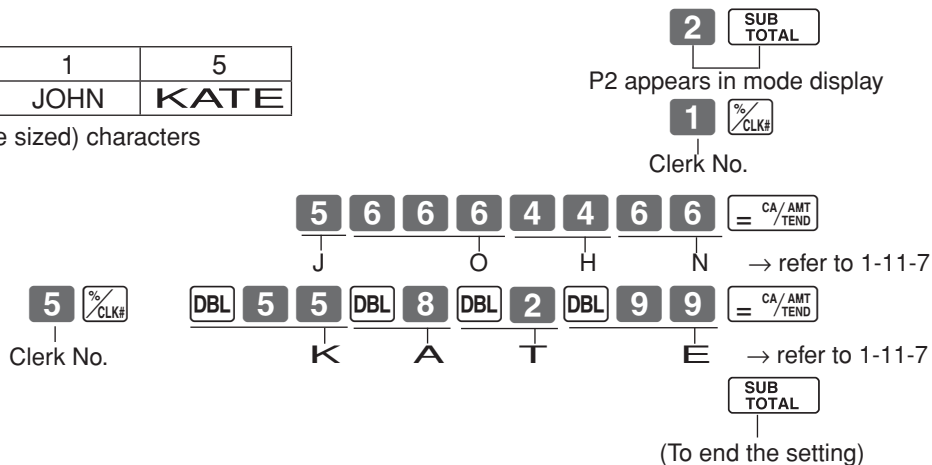

1-11-6 Programming receipt message

Example

Line (1 ~ 5)	2
Message	THANK YOU

up to 24 (12 double sized) characters

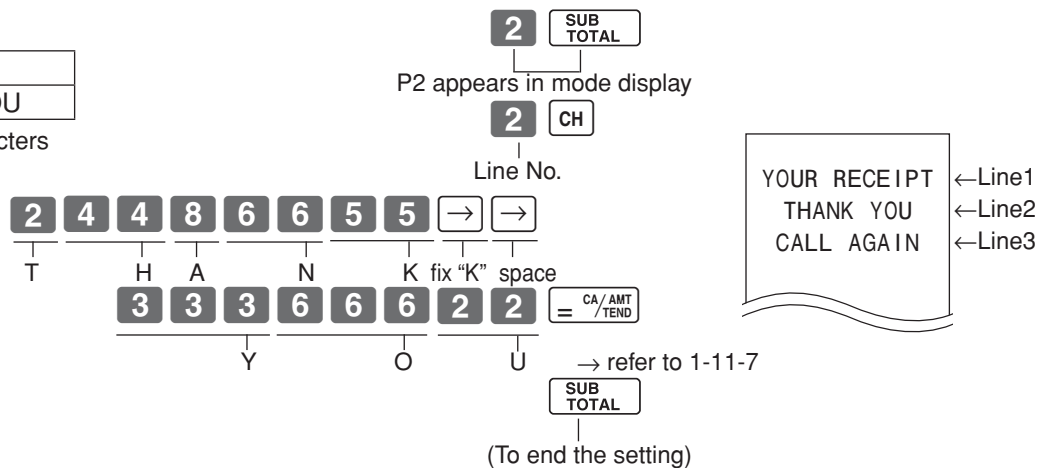

1-11-7 Alphabetical order

Characters are assigned to each numeric key. You can enter "A" by pressing **8** once, "B" twice, "C" three times ...

The following tables indicate character assignment and the depression numbers of the key to enter the appropriate character.

A, B, C, a, b, c, 8, ... 8 key	: A → B → C → a → b → c → 8 → A 01 B 02 C 03 a 04 b 05 c 06 8 07
	→ Ä → Å → Æ → Á → Â → Ã → Ä → A 08 A 09 A 10 A 11 A 12 A 13 A 14
	→ Ç → à → á → â → ã → ä → å → C 15 a 16 a 17 a 18 a 19 a 20 a 21
	→ ä → ç → returns to the beginning a 22 c 23
D, E, F, d, e, f, 9, ... 9 key	: D → E → F → d → e → f → 9 → D 01 E 02 F 03 d 04 e 05 f 06 9 07
	→ Ð → É → Ê → Ë → È → Ï → ê → D 08 E 09 E 10 E 11 E 12 d 13 e 14
	→ ê → ë → è → f → returns to the beginning e 15 e 16 e 17 f 18
G, H, I, g, h, i, 4, ... 4 key	: G → H → I → g → h → i → 4 → G 01 H 02 I 03 g 04 h 05 i 06 4 07
	→ î → ï → í → ï → ì → ï → ï → I 08 I 09 I 10 I 11 I 12 i 13 i 14
	→ ï → ï → ï → returns to the beginning i 15 i 16 i 17
J, K, L, j, k, l, 5, ... 5 key	: J → K → L → j → k → l → 5 → J 01 K 02 L 03 j 04 k 05 l 06 5 07
	→ returns to the beginning
M, N, O, m, n, o, 6, ... 6 key	: M → N → O → m → n → o → 6 → M 01 N 02 O 03 m 04 n 05 o 06 6 07
	→ Ñ → Ö → Ø → Ó → Ô → Õ → Ö → N 08 O 09 O 10 O 11 O 12 O 13 O 14
	→ ñ → ô → ö → ò → ø → ó → ö → m 15 o 16 o 17 o 18 o 19 o 20 o 21
	→ returns to the beginning

Part-2 CONVENIENT OPERATION

P, Q, R, S, p, q, r, s, 1, ... 1 key	: P → Q → R → S → p → q → r →
	P 01 Q 02 R 03 S 04 p 05 q 06 r 07
T, U, V, t, u, v, 2, ... 2 key	→ s → l → p → β → returns to the beginning
	s 08 l 09 p 10 β 12
W, X, Y, Z, w, x, y, z, 3, ... 3 key	: T → U → V → t → u → v → 2 →
	T 01 U 02 V 03 t 04 u 05 v 06 2 07
	→ Ū → Ū → Ū → Ū → Ū → Ū → Ū →
0 0 key	→ returns to the beginning
	0 01
7, Symbols, ... 7 key	: 7 → @ → - → / → : → ! → ? →
	7 01 @ 02 - 03 / 04 : 05 ! 06 ? 07
	→ ^ → (→) → * → # → + → , →
	^ 08 (09) 10 * 11 # 12 + 13 , 14
	→ ^ → ; → < → = → > → \$ → ¥ →
	^ 15 ; 16 < 17 = 18 > 19 \$ 20 ¥ 21
	→ % → & → [→] → ' → { → →
% 22 & 23 [24] 25 ' 26 { 27 28	
→ } → . → " → . → \ → _ → ` →	
} 29 . 30 " 31 . 32 \ 33 _ 34 ` 35	
→ £ → × → ÷ → i → € → § → space →	
£ 36 × 37 ÷ 38 i 39 € 40 § 41 space 42	
→ returns to the beginning	

Cf.

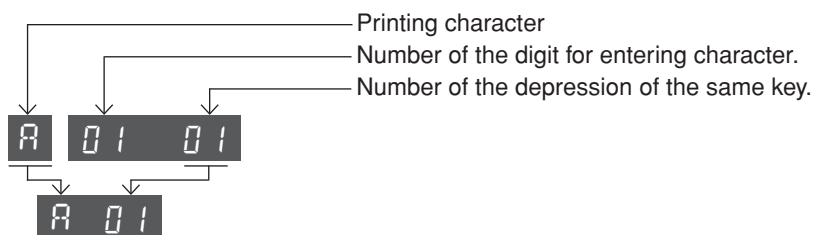

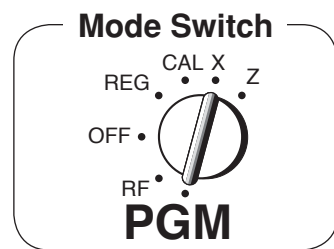

1-12-2 Printing preset PLU settings



1

= CA/AMT / TEND

PLU0001	@1.00
#0001	0000
PLU0002	@2.00
#0002	0002
PLU0003	@3.00
#0003	0000
PLU0004	@4.00
#0004	0000
PLU0199	@1,999.00
#0199	0000
PLU0500	@500.00
#0500	

PLU Name/Unit Price
PLU No./Program

Stop printing by **SUB TOTAL** **SUB TOTAL** .

2. Various Operations

2-1 Registration using preset price for Departments.

(Programming: See page 20)

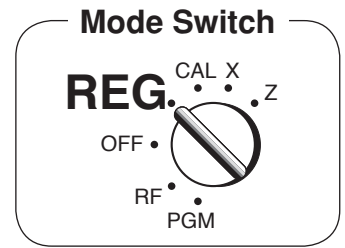

Operation	Printout																																																						
<table border="1"> <tr> <td>Unit Price</td> <td>\$1.00</td> <td>\$2.20</td> <td>\$11.00</td> </tr> <tr> <td>Quantity</td> <td>1</td> <td>2</td> <td>4</td> </tr> <tr> <td>Depts.</td> <td>1</td> <td>2</td> <td>3</td> </tr> <tr> <td>Amount tendered</td> <td colspan="3">\$50.00</td> </tr> </table> <table border="1"> <tr> <td>5</td><td>0</td><td>0</td><td>0</td> </tr> </table> <table border="1"> <tr> <td>+ 1</td> <td>8/11/18</td> </tr> <tr> <td>- 2</td> <td>7/12/17</td> </tr> <tr> <td>- 2</td> <td>7/12/17</td> </tr> <tr> <td>4</td> <td>X/DATE TIME</td> </tr> <tr> <td>x 3</td> <td>8/12/18</td> </tr> <tr> <td>SUB TOTAL</td> <td></td> </tr> <tr> <td>= CA/AMT TEND</td> <td></td> </tr> </table>	Unit Price	\$1.00	\$2.20	\$11.00	Quantity	1	2	4	Depts.	1	2	3	Amount tendered	\$50.00			5	0	0	0	+ 1	8/11/18	- 2	7/12/17	- 2	7/12/17	4	X/DATE TIME	x 3	8/12/18	SUB TOTAL		= CA/AMT TEND		<table border="1"> <tr> <td>08-01-2010</td> <td>15:30</td> </tr> <tr> <td>REG</td> <td>0040</td> </tr> <tr> <td>DEPT01</td> <td>· 1.00</td> </tr> <tr> <td>DEPT02</td> <td>· 2.20</td> </tr> <tr> <td>DEPT02</td> <td>· 2.20</td> </tr> <tr> <td>4 X</td> <td>@11.00</td> </tr> <tr> <td>DEPT03</td> <td>· 44.00</td> </tr> <tr> <td>TOTAL</td> <td>· 49.40</td> </tr> <tr> <td>CASH</td> <td>· 50.00</td> </tr> <tr> <td>CHANGE</td> <td>· 0.60</td> </tr> </table> <p>Repeat Multiplication/Unit Price Cash Amount Tendered Change</p>	08-01-2010	15:30	REG	0040	DEPT01	· 1.00	DEPT02	· 2.20	DEPT02	· 2.20	4 X	@11.00	DEPT03	· 44.00	TOTAL	· 49.40	CASH	· 50.00	CHANGE	· 0.60
Unit Price	\$1.00	\$2.20	\$11.00																																																				
Quantity	1	2	4																																																				
Depts.	1	2	3																																																				
Amount tendered	\$50.00																																																						
5	0	0	0																																																				
+ 1	8/11/18																																																						
- 2	7/12/17																																																						
- 2	7/12/17																																																						
4	X/DATE TIME																																																						
x 3	8/12/18																																																						
SUB TOTAL																																																							
= CA/AMT TEND																																																							
08-01-2010	15:30																																																						
REG	0040																																																						
DEPT01	· 1.00																																																						
DEPT02	· 2.20																																																						
DEPT02	· 2.20																																																						
4 X	@11.00																																																						
DEPT03	· 44.00																																																						
TOTAL	· 49.40																																																						
CASH	· 50.00																																																						
CHANGE	· 0.60																																																						

2-2 Single-Item Sales

(Programming: See page 21)

Example 1:

Status	Single item sale
Unit Price	\$0.50
Quantity	1
Dept.	1

5 0 + 1

08-01-2010	15:45
REG	0041
DEPT01	· 0.50
CASH	· 0.50

Cash Sales

For this example, Dept. 1 is programmed for a single-item-sale.

Example 2:

Status	Normal	Single item sale
Unit Price	\$1.00	\$0.50
Quantity	1	1
Dept.	2	1

1 0 0 - 2

5 0 + 1

08-01-2010	16:00
REG	0042
DEPT02	· 1.00
DEPT01	· 0.50
CASH	· 1.50

Cash Sales

Single-item sale cannot be finalized if an item is registered previously.

2-3 Check sales

Example

Unit Price	\$35.00
Quantity	2
Depts.	4

3 5 0 0

+ 4

+ 4

SUB TOTAL

CHK /NS

08-01-2010	16:10
REG	0043
DEPT04	· 35.00
DEPT04	· 35.00
CHECK	· 70.00

Check Sales

Part-2 CONVENIENT OPERATION

2-4 Split cash/ check sales

Example

Unit Price	\$30.00	\$25.00
Quantity	1	1
Depts.	2	3
Cash amount tendered	\$20.00	
Check	\$35.00	

3 0 0 0 - 2
7/12/17
2 5 0 0 x 3
8/13/18
SUB
TOTAL
2 0 0 0 = CA/AMT
TEND
CHK
/NS

08-01-2010	16:15
REG	0044
DEPT02	·30.00
DEPT03	·25.00
TOTAL	·55.00
CASH	·20.00
CHECK	·35.00

2-5 Post receipt issuance

Example

Unit Price	\$1.00	\$2.00
Quantity	1	1
Depts.	1	2
Cash amount tendered	\$5.00	



1 0 0 + 1
7/12/17
2 0 0 - 2
8/13/18
SUB
TOTAL
5 0 0 = CA/AMT
TEND
(Receipt is not issued.)
POST
RECEIPT
(Receipt is issued.)

Note:

You can issue only one post receipt per transaction.

You can issue a post receipt after finalizing a transaction by pressing .

Note that all of the following condition must be satisfied:

- Print "receipt" option is selected.
- Paper Saving mode must be "ON".
- The transaction must be finalized in the REG/RF mode using ,  or .

(Post receipt)

08-01-2010	16:25
REG	0045
DEPT01	·1.00
DEPT02	·2.00
TOTAL	·3.00
CASH	·5.00
CHANGE	·2.00

If the transaction contains more than 40 lines (including receipt header), then the total formatted post receipt is issued.

(Total formatted post receipt)

08-01-2010	16:25
REG	0045
CASH	·3.00

2-6 Refund

Mode Switch

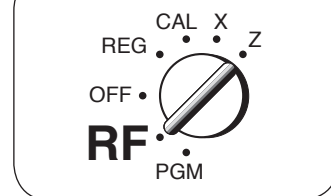

Operation

Printout

Example

Unit Price	\$1.00	\$2.00
Quantity	1	1
Depts.	2	3

1 0 0 - 2
7/12/17
2 0 0 x 3
8/13/18
SUB
TOTAL
= CA/AMT
TEND

08-01-2010	16:55
RF	0050
DEPT02	·1.00
DEPT03	·2.00
CASH	·3.00

Refund Mode
Indicator

After you finish RF mode operation, be sure to return the Mode Switch to the REG (register) setting.

2-7 PLU operation

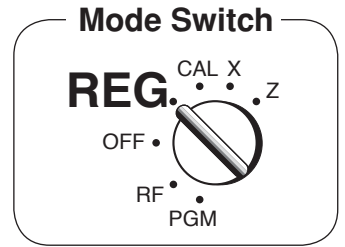

2-7-1 PLU registration

(Programming: See page 26)

Example

PLU No.	1	2
Unit Price	\$1.00	\$2.00
Quantity	2	4
Depts.	1	1
Cash amount tendered	\$10.00	

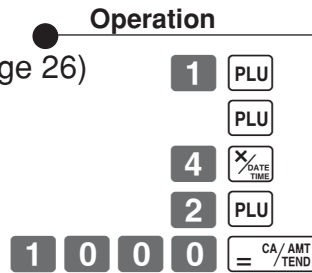

Printout

08-01-2010	17:00	
REG	0051	
PLU0001	·1.00	
PLU0001	·1.00	Repeat
4 X	@2.00	Multiplication
PLU0002	·8.00	Preset Unit Price
TOTAL	·10.00	
CASH	·10.00	Cash Amount Tendered
CHANGE	·0.00	

2-7-2 PLU Single-Item Sale

(Programming: See page 26)

Example

PLU No.	1
Status	Single item sale
Unit Price	\$1.00
Quantity	1

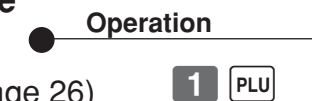

Printout

08-01-2010	17:10
REG	0052
PLU0001	·1.00
CASH	·1.00

- For this example, linked department 1 is programmed for a single-item-sale.
- Single-item sale cannot be finalized if an item is registered previously.

2-7-3 PLU report

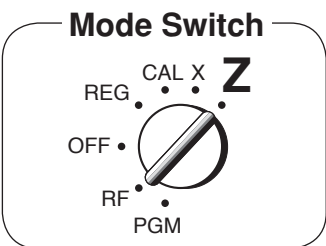
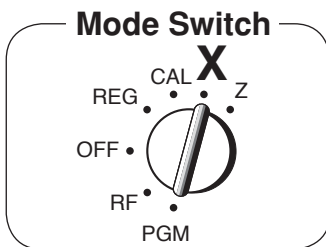

Operation

Printout



08-01-2010	17:20	
Z	0055	
0001 PLU	Z 0001	Reset Counter
PLU0001	QT 12	PLU Name/No. of items
	·12.00	Amount
PLU0002	QT 27	
	·27.00	
PLU0500	QT	
	·180.00	

TOTAL	QT 1284	PLU total count
	·10856.89	PLU total amount

2-8 Other registrations

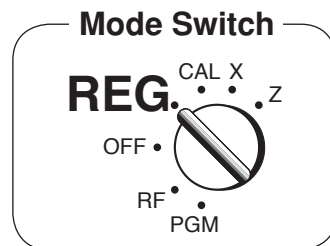

2-8-1 Reading the Time and Date

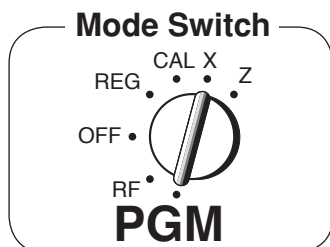
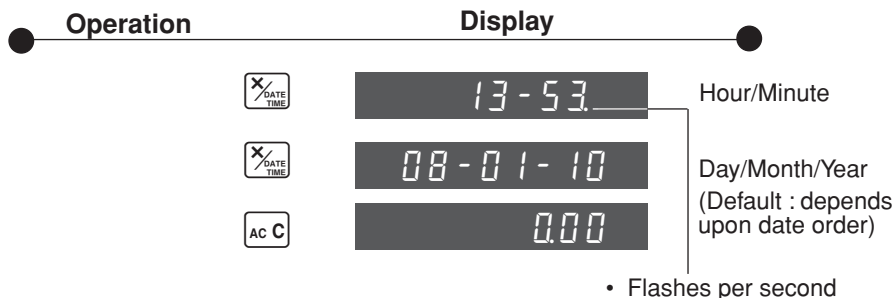

Adjusting the Time

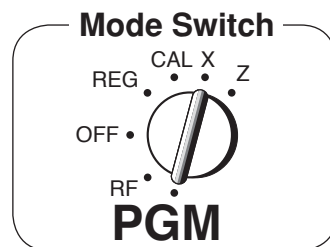
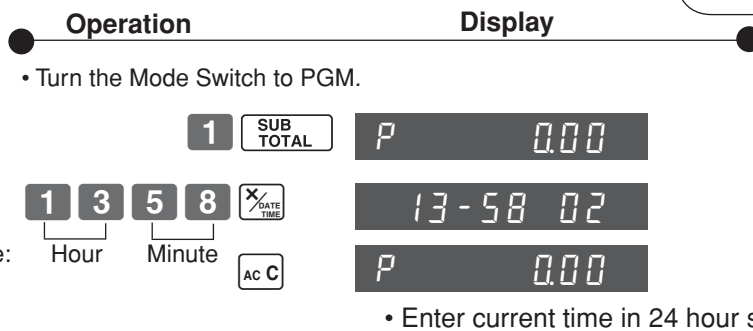

Adjusting the Date

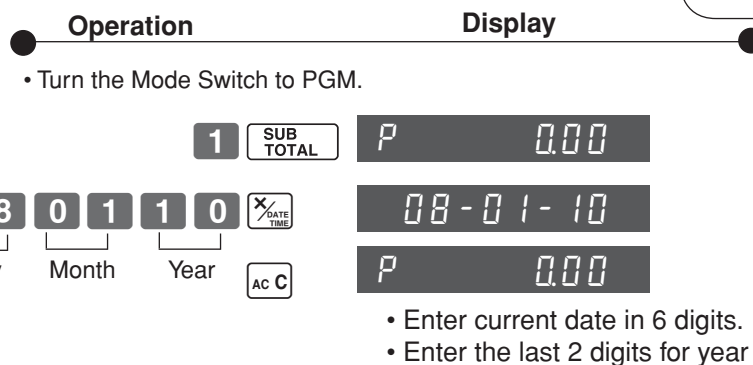

• If you have changed the date order (refer to page 12), enter date of that order.

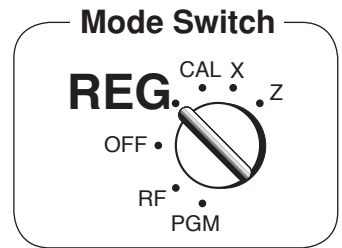

2-8-2 Paid out from cash in drawer

Operation	Printout																							
<table border="0"> <tr> <td>1</td><td>2</td><td>3</td><td>4</td> </tr> <tr> <td>5</td><td>6</td><td>7</td><td>8</td> </tr> </table> Enter reference No.	1	2	3	4	5	6	7	8	<table border="0"> <tr> <td>#</td> <td style="text-align: right;">12345678</td> <td>Reference Number</td> </tr> <tr> <td colspan="3"><hr/></td> </tr> <tr> <td>08-01-2010</td> <td style="text-align: right;">17:20</td> <td></td> </tr> <tr> <td>REG</td> <td style="text-align: right;">0057</td> <td></td> </tr> <tr> <td>PD</td> <td style="text-align: right;">·10.00</td> <td>Paid Out Amount</td> </tr> </table>	#	12345678	Reference Number	<hr/>			08-01-2010	17:20		REG	0057		PD	·10.00	Paid Out Amount
1	2	3	4																					
5	6	7	8																					
#	12345678	Reference Number																						
<hr/>																								
08-01-2010	17:20																							
REG	0057																							
PD	·10.00	Paid Out Amount																						

2-8-3 Cash received on account

Operation	Printout														
<table border="0"> <tr> <td>6</td><td>0</td><td>0</td> </tr> </table> <table border="0"> <tr> <td>RC</td><td>MR</td> </tr> </table>	6	0	0	RC	MR	<table border="0"> <tr> <td>08-01-2010</td> <td style="text-align: right;">17:25</td> <td></td> </tr> <tr> <td>REG</td> <td style="text-align: right;">0058</td> <td>Received On Account Amount</td> </tr> <tr> <td>RC</td> <td style="text-align: right;">·6.00</td> <td></td> </tr> </table>	08-01-2010	17:25		REG	0058	Received On Account Amount	RC	·6.00	
6	0	0													
RC	MR														
08-01-2010	17:25														
REG	0058	Received On Account Amount													
RC	·6.00														

2-8-4 Registering identification numbers

A reference number or ID number of up to 8 digits can be registered prior to any transaction.

Operation	Printout																																	
<table border="0"> <tr> <td>5</td><td>0</td> </tr> <tr> <td>+ 1</td> <td>8/11/15</td> </tr> </table> <table border="0"> <tr> <td>1</td><td>2</td><td>3</td><td>4</td> </tr> <tr> <td>5</td><td>6</td><td>7</td><td>8</td> </tr> </table> <table border="0"> <tr> <td>#</td><td>DEPT</td><td>SHIFT</td> </tr> </table> <table border="0"> <tr> <td>=</td><td>CA / AMT</td><td>TEND</td> </tr> </table>	5	0	+ 1	8/11/15	1	2	3	4	5	6	7	8	#	DEPT	SHIFT	=	CA / AMT	TEND	<table border="0"> <tr> <td>08-01-2010</td> <td style="text-align: right;">17:35</td> <td></td> </tr> <tr> <td>REG</td> <td style="text-align: right;">0059</td> <td></td> </tr> <tr> <td>DEPT01</td> <td style="text-align: right;">·0.50</td> <td></td> </tr> <tr> <td>#</td> <td style="text-align: right;">12345678</td> <td>Reference Number or ID No.</td> </tr> <tr> <td>CASH</td> <td style="text-align: right;">·0.50</td> <td></td> </tr> </table>	08-01-2010	17:35		REG	0059		DEPT01	·0.50		#	12345678	Reference Number or ID No.	CASH	·0.50	
5	0																																	
+ 1	8/11/15																																	
1	2	3	4																															
5	6	7	8																															
#	DEPT	SHIFT																																
=	CA / AMT	TEND																																
08-01-2010	17:35																																	
REG	0059																																	
DEPT01	·0.50																																	
#	12345678	Reference Number or ID No.																																
CASH	·0.50																																	

2-8-5 Reduction on subtotal

Example:
Amount due reduced by \$0.50.

Operation	Printout																																						
<table border="0"> <tr> <td>1</td><td>0</td><td>0</td> </tr> <tr> <td>+ 1</td> <td>8/11/15</td> </tr> </table> <table border="0"> <tr> <td>2</td><td>0</td><td>0</td> </tr> <tr> <td>+ 4</td> <td>8/14/15</td> </tr> </table> <table border="0"> <tr> <td>SUB</td><td>TOTAL</td> </tr> </table> <table border="0"> <tr> <td>5</td><td>0</td> </tr> <tr> <td>-</td><td>ERR</td><td>CORR</td> </tr> </table> <table border="0"> <tr> <td>=</td><td>CA / AMT</td><td>TEND</td> </tr> </table>	1	0	0	+ 1	8/11/15	2	0	0	+ 4	8/14/15	SUB	TOTAL	5	0	-	ERR	CORR	=	CA / AMT	TEND	<table border="0"> <tr> <td>08-01-2010</td> <td style="text-align: right;">17:45</td> <td></td> </tr> <tr> <td>REG</td> <td style="text-align: right;">0060</td> <td></td> </tr> <tr> <td>DEPT01</td> <td style="text-align: right;">·1.00</td> <td></td> </tr> <tr> <td>DEPT04</td> <td style="text-align: right;">·2.00</td> <td></td> </tr> <tr> <td>-</td> <td style="text-align: right;">-0.50</td> <td></td> </tr> <tr> <td>CASH</td> <td style="text-align: right;">·2.50</td> <td></td> </tr> </table>	08-01-2010	17:45		REG	0060		DEPT01	·1.00		DEPT04	·2.00		-	-0.50		CASH	·2.50	
1	0	0																																					
+ 1	8/11/15																																						
2	0	0																																					
+ 4	8/14/15																																						
SUB	TOTAL																																						
5	0																																						
-	ERR	CORR																																					
=	CA / AMT	TEND																																					
08-01-2010	17:45																																						
REG	0060																																						
DEPT01	·1.00																																						
DEPT04	·2.00																																						
-	-0.50																																						
CASH	·2.50																																						

Part-2

2-8-6 Premium/Discount

•2.5% premium/discount (programmed to [%] key) applied to first item.

- 7% premium/discount applied to transaction total.
- For programming the [%] key as percent minus or percent plus, see page 22.
- For programming percent rate, see page 20.

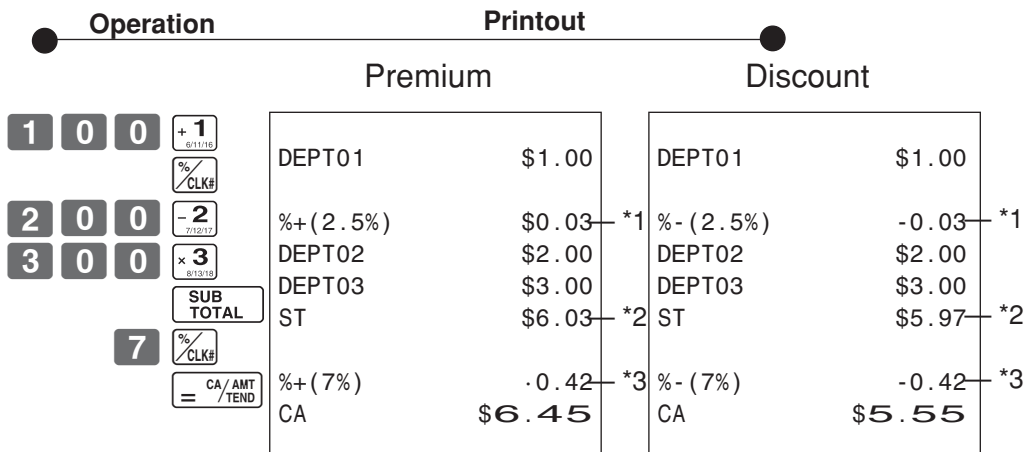

*1 Premium/Discount Rate
Premium/Discount Amount
*2 Subtotal
*3 Premium/Discount Rate
Premium/Discount Amount

2-9 Cashier Assignment

(Programming: See page 23)

Mode Switch
In any mode
REG, RF, CAL,
X or Z,
except **PGM**

Cashier assignment system is used to control each cashier (or clerk) sales total. When you select this function on page 23, you can get 8 cashiers (or clerk) sales data. Cashier assignment must be performed prior to starting registration or any other operation, except Program mode.

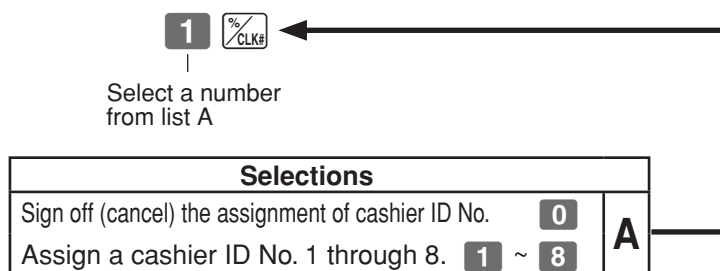

- Currently assigned cashier (or clerk) ID number is printed on the receipt or journal for each transaction.
- The assigned clerk memory number is automatically signed off when the mode key is set to OFF position.
- The assigned cashier (or clerk) sales totals with ID number are printed on the receipt or journal when you perform daily X/Z sales report.

Part 3

CALCULATOR FUNCTION

1. Calculator Mode

While registering at REG mode, you can switch to CAL mode and then return to REG mode to resume the registration.

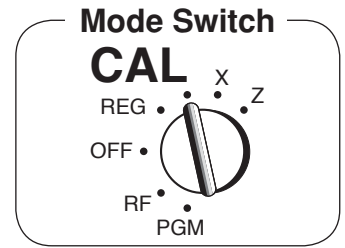
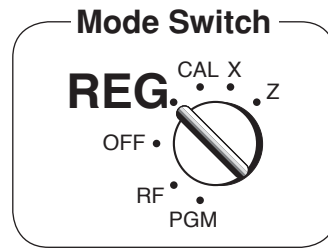

1-1 Calculation examples



5+3-2=

(23-56)×78=

(4×3-6)÷3.5+8=

12% on 1500

AC c

5 +¹ 1 AC c

(Miss operation)
(Cancels item entered.)

5 +¹ 3 -² 2 = CA/AMT TEND

2 3 -² 5 6 ×³ 7 8 = CA/AMT TEND

4 ×³ 3 -² 6 ÷⁴ 3 · 5 +¹ 8 = CA/AMT TEND

1 5 0 0 ×³ 1 2 % CLK#



1-2 Memory recall

Recalls the current amount onto the display.

- during registration: current subtotal
- registration has been completed: the last amount



On REG mode

1 0 00 +¹ 2 0 00 -²

On CAL mode

Example:

Divide the current subtotal \$30.00 at REG mode by 3 (to divide the bill between 3 people).

RC/MR ÷⁴ 3 = CA/AMT TEND



Memory recall

Recalls the current result by pressing **RC/MR** key at CAL mode on the display.



On REG mode

Example:

Recall the current result at CAL mode during registration, and register the cash amount due for each person.

RC/MR = CA/AMT TEND

RC/MR = CA/AMT TEND

RC/MR = CA/AMT TEND

Memory recall

DEPT01	· 10.00
DEPT02	· 10.00
TOTAL	· 30.00
CA	· 10.00
CA	· 10.00
CA	· 10.00
CG	· 0.00

1-3 Setting for calculator operation

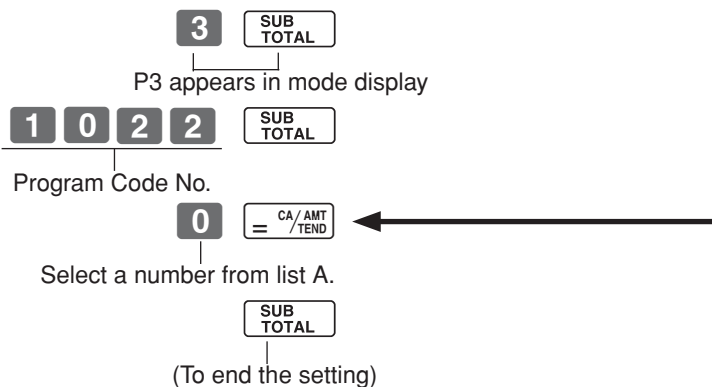
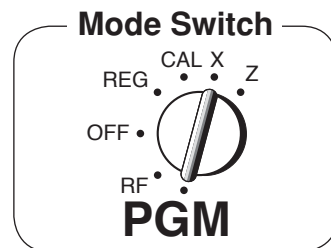

Selections			
Open drawer whenever = CA/AMT /TEND is pressed.*			
Open drawer whenever CHK /NS is pressed.*			
Print No. of Equal key operations on General Control X and Z reports.			
Yes	No	No	0
	Yes	Yes	1
No	No	No	2
	Yes	Yes	3
Yes	No	No	4
	Yes	Yes	5
No	No	No	6
	Yes	Yes	7

A

*Drawer does not open during registration procedures even if you press **= CA/AMT /TEND** or **CHK /NS** by turning the mode switch to CAL position.



USEFUL INFORMATION

1. Troubleshooting

1-1 If the following things happen

	Symptom/Problem	Most common causes	Solutions
1	E01 appears on the display.	Changing modes without completing transaction.	Return mode switch to where it stops buzzing and press .
2	E08 appears on the display.	Sign on operation is not performed.	Prior to starting registration of any other operation, press 1 ~ 8 and then .
3	E10 appears on the display.	Printer head (platen arm) is opened or no paper roll.	Close the platen arm firmly or enter paper roll.
4	E90 appears on the display.	Totals remain in the memory.	Issue the general control reset report, periodic reset report and PLU reset report.
5	E81 appears on the display.	Electronic journal memory becomes/ is full.	Issue electronic journal reset report. (refer to page 18)
6	No date on receipt. Paper is not advancing enough.	Printer is programmed as a journal.	Program printer to print receipts.
7	Drawer opens up after ringing up only one time.	Department is programmed as a single item dept.	Program the dept. as a normal dept.
8	Not clearing totals at end of day after taking report.	Using X mode to take out reports.	Use Z mode to take out reports.
9	Programming is lost whenever register is unplugged or there is a power outage.	Bad or no batteries.	Put in new batteries.
10	Register is inoperative. Can't get money out of drawer.	No power.	Pull lever underneath register at rear.

Part-4

1-2 In case of power failure

If the power supply to the cash register is cut by a power failure or any other reason, simply wait for power to be restored. The details of any ongoing transaction as well as all sales data in memory are protected by the memory backup batteries.

- Power failure during a registration
The subtotal for items registered up to the power failure is retained in memory. You will be able to continue with the registration when power is restored.
- Power failure during printing a read/reset report
The data already printed before the power failure is retained in memory. You will be able to issue a report when power is restored.
- Power failure during printing of a receipt and the journal
Printing will resume after power is restored. A line that was being printed when the power failure occurred is printed in full.
- Other
The power failure symbol is printed and any item that was being printed when the power failure occurred is reprinted in full.

1-3 When the L sign appears on the display

About the low battery indicator...

The following shows the low battery indicator.



If this indicator appears when you switch the cash register on, it can mean one of three things:

- No memory backup batteries are loaded in the cash register.
- The power of the batteries loaded in the unit is below a certain level.
- The batteries loaded in the unit are dead.

To clear this sign, press  key.

Important!

Whenever the low battery indicator appears on the display, load a set of 2 new batteries as soon as possible. If there is a power failure or you unplug the cash register when this indicator appears, you will lose all of your sales data and settings.

BE SURE TO KEEP THE POWER CORD OF THE CASH REGISTER PLUGGED IN WHENEVER YOU REPLACE THE BATTERIES.

2. Specifications

INPUT METHOD

Entry: 10-key system; Buffer memory 8 keys (2-key roll over)

Display (LED): Amount 8 digits (zero suppression); Department/PLU No.; No. of repeats

PRINTER

Receipt: 12 digits (Amount 10 digits, Symbol 2 digits)

(or Journal) Automatic paper roll winding (journal)

Paper roll: 58 mm × 80 mm Ø (Max.)

CALCULATIONS

Entry 8 digits; Registration 7 digits; Total 8 digits

CALCULATOR FUNCTION

8 digits; Arithmetic calculations; Percent calculations

Memory protection batteries:

The effective service life of the memory protection batteries 2 (UM-3, or R6P (SUM-3) type batteries) is approximately one year from installation into the machine.

Power source/Power consumption: See the rating plate.

Operating temperature: 0°C to 40°C (32°F to 104°F)

Humidity: 10 to 90%

Dimensions/Weight: 188 mm(H) × 330 mm(W) × 360 mm(D) with S drawer

4 kg with S drawer

205 mm(H) × 410 mm(W) × 450 mm(D) with M drawer

8 kg with M drawer

Specifications and design are subject to change without notice.

When the cash drawer does not open!

In case of power failure or the machine is in malfunction, the cash drawer does not open automatically. Even in these cases, you can open the cash drawer by pulling drawer release lever (see below).

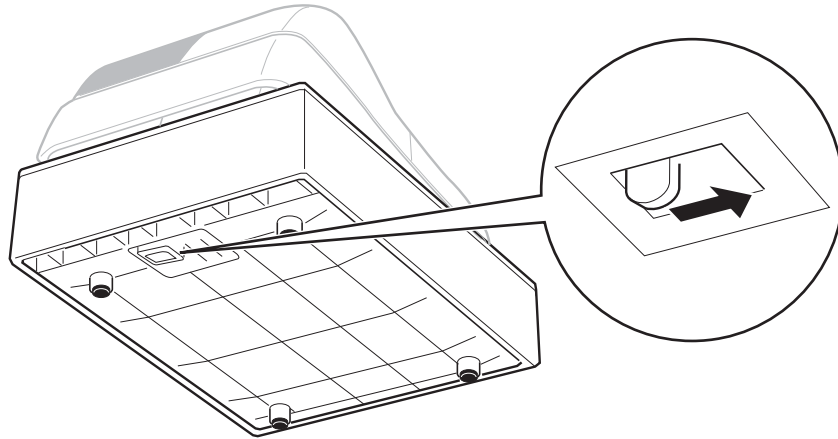

Important!

The drawer will not open, if it is locked with a drawer lock key.

Laite on liitettävä suojamaadoituskostkettimilla vaurstettuun pistrasiaan
Apparatet må tiloples jordet dtikkontakt
Apparaten skall anslutas till jordat nätuttag



This mark applies in EU countries only.



Manufacturer:
CASIO COMPUTER CO., LTD.
6-2, Hon-machi 1-chome, Shibuya-ku Tokyo 151-8543, Japan
Representative within the European Union:
Casio Europe GmbH
Casio-Platz 1, 22848 Norderstedt Germany

Please keep all information for future reference.

CASIO®

CASIO COMPUTER CO., LTD.
6-2, Hon-machi 1-chome
Shibuya-ku, Tokyo 151-8543, Japan

CR0906-A

SE-S10*E
Printed in Indonesia
Printed on recycled paper.